

# ***KTM*** POWERPARTS **INFORMATION**

HEATED GRIP KIT



64112964044

11.2019  
3.213.827



KTM Sportmotorcycle GmbH  
5230 Mattighofen, Austria  
www.ktm.com



## 3 DEUTSCH

Wir freuen uns, dass Sie sich für dieses Produkt entschieden haben.

Unser hochwertiges Qualitätsprodukt ist rennerprobt und wurde speziell für sportliche Herausforderungen entwickelt. Eine korrekte Montage des Produktes ist unerlässlich, um ein Maximum an Sicherheit und Funktionalität gewährleisten zu können. Bitte befolgen Sie daher die Montageanleitung oder wenden Sie sich an Ihren autorisierten Fachhändler.

**Für falsche Montage oder Verwendung dieses Produktes kann der (Quasi-)Hersteller bzw. Lieferant nicht zur Verantwortung gezogen werden.**  
Vielen Dank.

## 15 ENGLISH

Thank you for choosing this product.

Our high quality product has been tested under racing conditions and was developed specifically for use in sports activities. Correct installation of the product is essential to ensure that a maximum degree of safety and functionality is achieved. Therefore, please follow the installation instructions or contact your authorized dealer.

**The (quasi) manufacturer or supplier cannot be held responsible for products that are incorrectly mounted or inappropriately used.**  
Thank you.

## 14 ITALIANO

Grazie per aver scelto questo prodotto.

Questo nostro prodotto di pregiata qualità è collaudato nelle competizioni ed è stato sviluppato specificamente per gare sportive. Il montaggio corretto del prodotto è fondamentale per garantirne la massima sicurezza e funzionalità. Rispetti quindi le istruzioni di montaggio o rivolgerti al proprio concessionario autorizzato.

**Il produttore (detentore del marchio)/fornitore non può essere considerato responsabile per un montaggio o impiego errato del presente prodotto.**  
Vi ringraziamo per l'attenzione!

## 19 FRANÇAIS

Merci d'avoir porté votre choix sur ce produit.

Notre produit de haute qualité est éprouvé pour les compétitions et a été conçu spécialement pour un usage sportif. Un montage approprié du produit est indispensable pour garantir une sécurité et une fonctionnalité maximales du véhicule. C'est pourquoi nous vous invitons à suivre scrupuleusement le manuel de montage ou à vous adresser à votre revendeur agréé.

**En cas de montage ou d'utilisation non conformes de ce produit, le (quasi) constructeur ou le fournisseur déclinent toute responsabilité.**  
Merci !

## 24 ESPAÑOL

Le agradecemos que se haya decidido por este producto.

Este producto de alta calidad está probado para la competición y se ha desarrollado específicamente para las exigencias de este deporte. Para poder garantizar los máximos niveles de seguridad y funcionalidad, es imprescindible que el producto se monte correctamente. Por este motivo, es muy importante que siga las instrucciones del manual de montaje o que se ponga en contacto con su concesionario autorizado.

**El (cuasi) fabricante y el proveedor de este producto no se harán responsables del montaje y el uso incorrectos.**  
¡Muchas gracias!

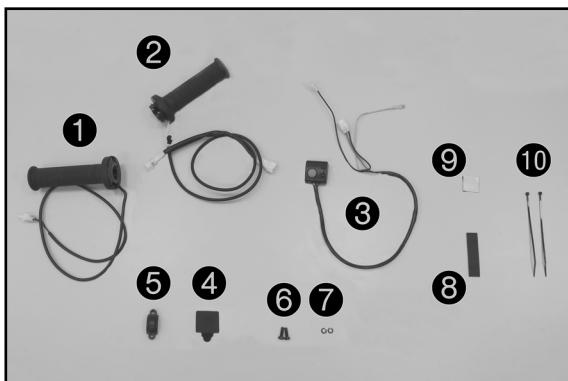

## Lieferumfang

- 1x Heizgriff links ①
- 1x Heizgriff rechts ②
- 1x Heizgriff Steuereinheit ③
- 1x Halterung oben ④
- 1x Halterung unten ⑤
- 2x Schraube M5x15 ⑥
- 2x Sprengring ⑦
- 1x Gummischutz ⑧
- 1x doppelseitiges Klebeband ⑨
- 2x Kabelbinder ⑩

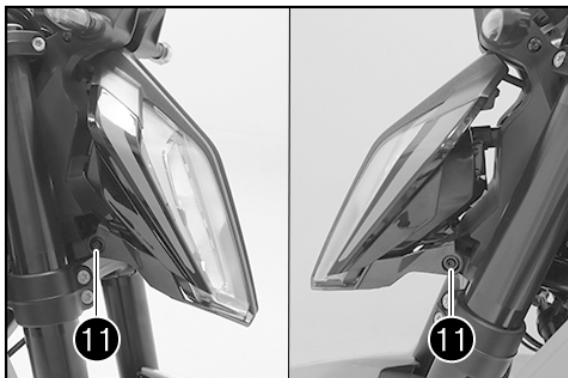

## 790 Duke

### Montage Heizgriffe

- Zündung ausschalten.
- Schrauben ⑪ entfernen.

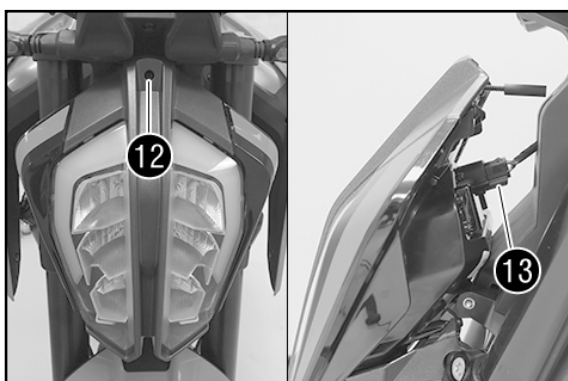

- Einstellschraube ⑫ komplett herausdrehen.

#### HINWEIS

Die Einstellschraube ist durch eine Kugelkopfhalterung an der Scheinwerfermaske befestigt.  
Die Einstellschraube nicht aus der Kugelkopfhalterung ziehen.

- Scheinwerfermaske leicht nach vorn schwenken und Stecker ⑬ abstecken.
- Scheinwerfer abnehmen.

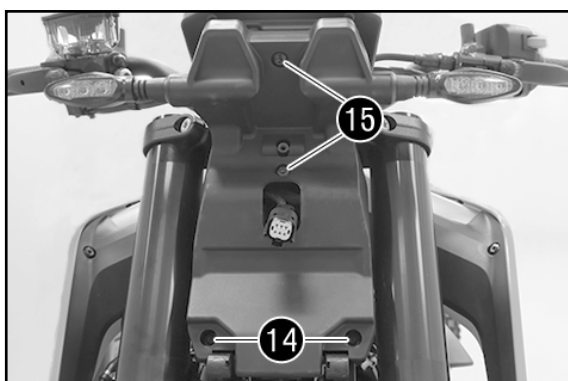

- Schrauben ⑭ entfernen.
- Schrauben ⑮ entfernen.
- Schrauben ⑯ entfernen.

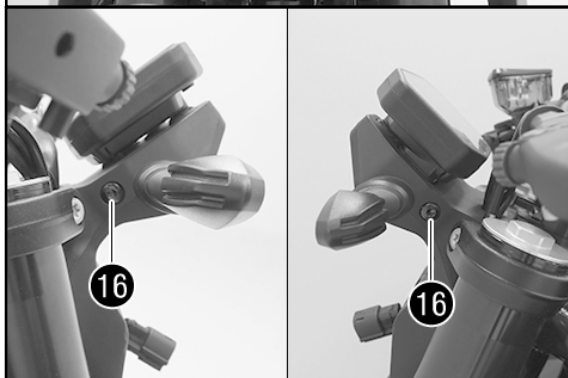

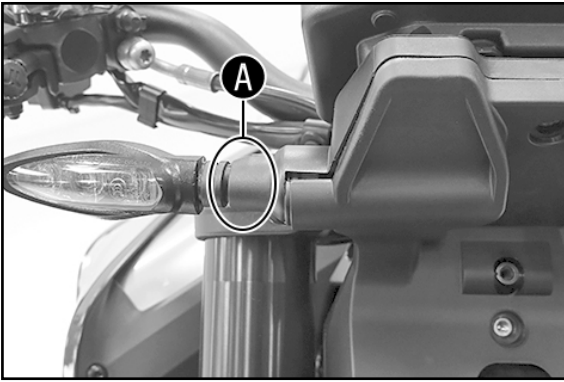

- Blinker im Bereich **A** greifen und vorsichtig entgegen der Fahrtrichtung drücken.

✓ Die Abdeckung löst sich wie im Bild ersichtlich.

- Arbeitsschritt auf der gegenüberliegenden Seite wiederholen.  
- Abdeckung entfernen.

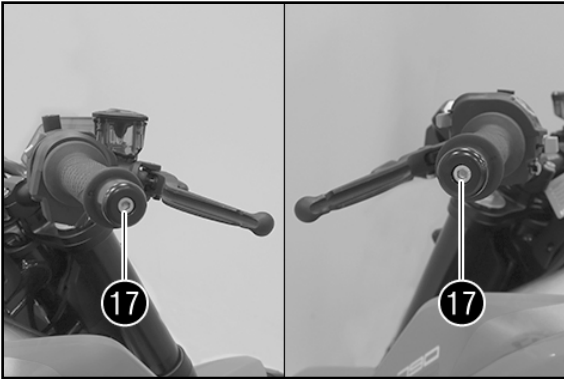

- Schrauben **17** lösen und Lenkergewicht entfernen.

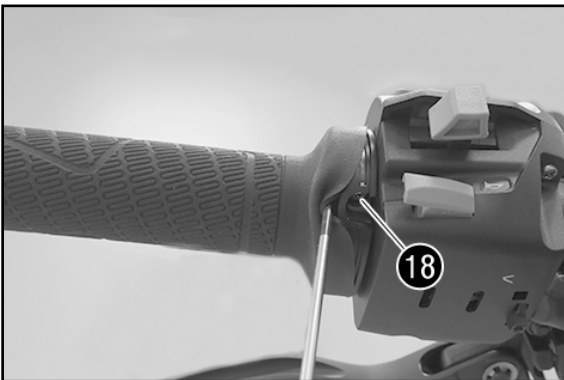

#### Linke Seite

- Griffgummi leicht anheben.  
- Schraube **18** lösen.  
- Festgriff entfernen.

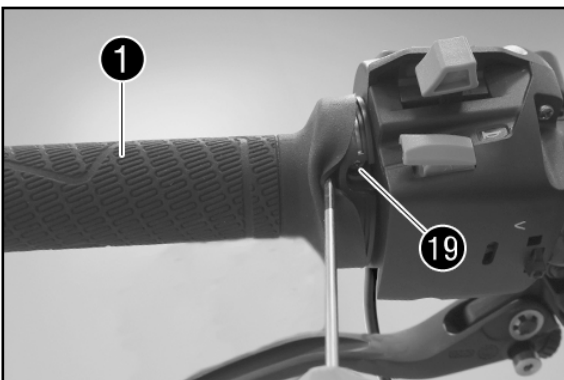

- Heizgriff links **1** (Lieferumfang) am Lenker positionieren.  
- Griffgummi leicht anheben.  
- Schraube **19** festziehen.



#### Rechte Seite

- Schrauben **20** entfernen.  
- Abdeckung abnehmen.  
- Gasdrehgriff vom Lenker ziehen.

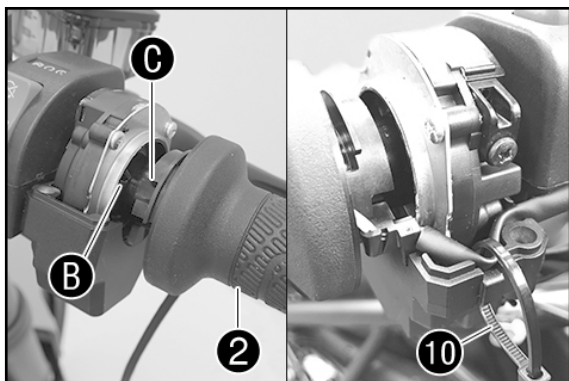

- Heizgriff rechts ② (Lieferumfang) am Lenker positionieren.

✓ Die Nase ⑥ greift im Mitnehmer ③ ein.

- Kabel im Gasdrehgriffsensor spannungsfrei verlegen (wie dargestellt) und mit Kabelbinder ⑩ (Lieferumfang) sichern.

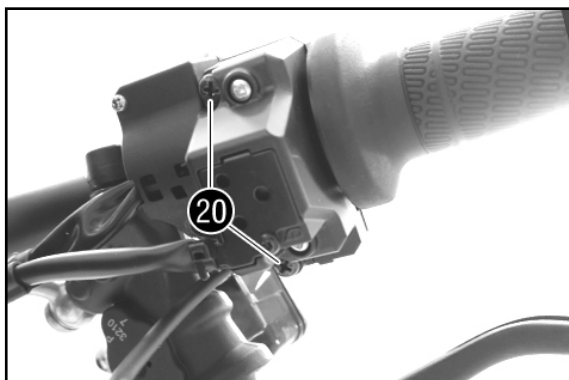

- Abdeckung positionieren.

**! VORSICHT**

Sicher stellen, dass das Kabel nicht geknickt oder geklemmt werden kann!

- Original-Schrauben ⑳ montieren und mit 3,5 Nm festziehen.

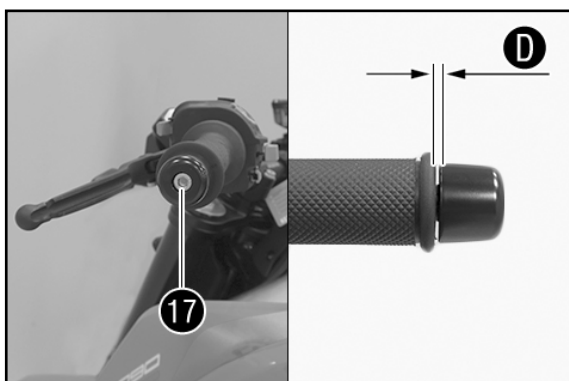

- Lenkergewicht links montieren und Schraube ⑰ mit 10 Nm festziehen.

- Lenkergewicht rechts im Abstand ① (2 mm) positionieren und Schraube ⑰ mit 10 Nm festziehen.

**HINWEIS**

Abstand beachten, um ein Klemmen des Gasdrehgriffes zu verhindern.

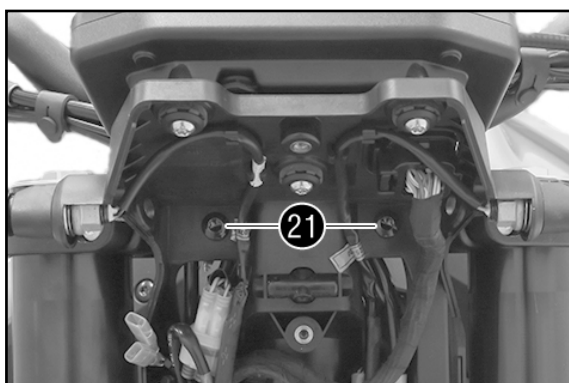

**Kabelverlegung**

- Schrauben ⑳ entfernen.

- Abdeckung leicht nach vorn ziehen.

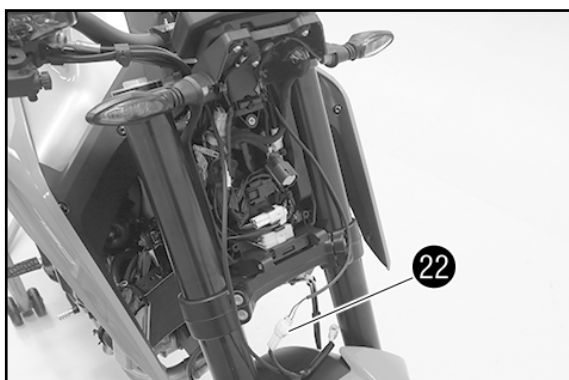

- Kabel der Heizgriffe beidseitig entlang der vorhandenen Kabel zur Scheinwerfermaske verlegen.

- Steckerverbindung ⑳ der beiden Heizgriffe zusammenstecken.



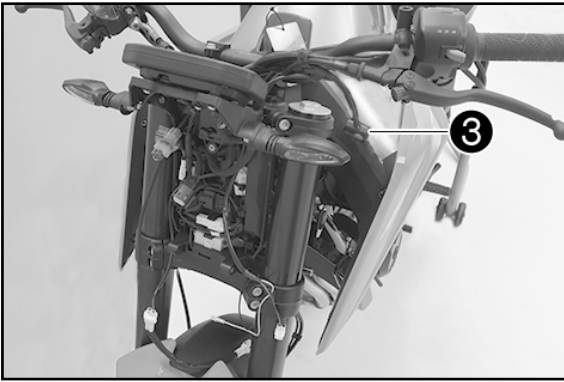

### Montage Steuereinheit

- Kabelstrang der Steuereinheit ③ (Lieferumfang), von der gewünschten Lenkerseite, entlang der vorhandenen Kabel zur Scheinwerfermaske verlegen.

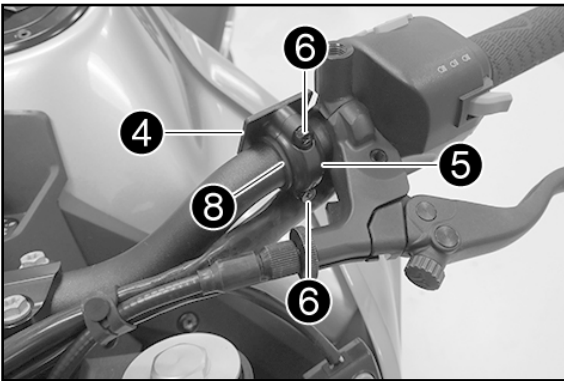

- Halterung oben ④ und unten ⑤ mit Gummischutz ③ (alles Lieferumfang) positionieren.  
- Schrauben ⑥ mit Sprengringen ⑦ (alles Lieferumfang) montieren und mit 2 Nm festziehen.

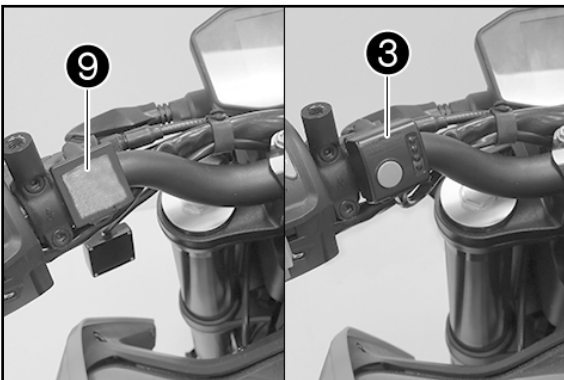

- Doppelseitiges Klebeband ⑨ (Lieferumfang) auf die Halterung oben ④ kleben.  
- Steuereinheit ③ aufkleben und ggf. mit Kabelbindern ⑩ (Lieferumfang) sichern.

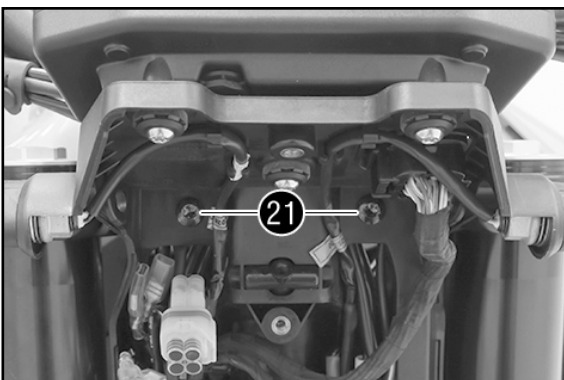

- Abdeckung positionieren und Schrauben ⑳ montieren und mit 5 Nm festziehen.

**! VORSICHT**  
Sicher stellen, dass das Kabel nicht geknickt oder geklemmt werden kann!

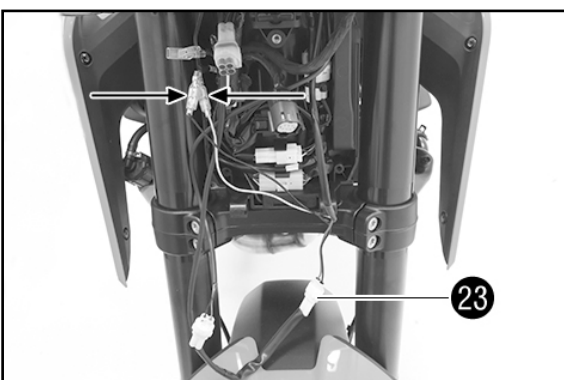

- Steckerverbindung ㉓ zusammenstecken.  
- Kabelstrang der Steuereinheit mit ACC2 des Fahrzeug-Kabelstrangs verbinden.

HINWEIS  
Auf den Kabeln befindet sich ein Aufkleber mit der Aufschrift ACC 2.

- Kabel spannungsfrei verlegen und ggf. mit Kabelbindern sichern.

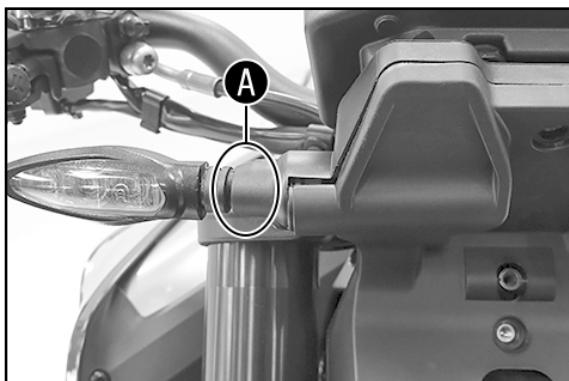

### Zusammenbau

- Abdeckung positionieren, dabei die Steckerverbindung des Scheinwerfers durch die Öffnung führen.
- Blinker im Bereich **A** greifen und vorsichtig entgegen der Fahrtrichtung drücken, gleichzeitig die Abdeckung festdrücken.
- ✓ Abdeckung rastet mit einem hörbaren Klicken ein.
- Arbeitsschritt auf der gegenüberliegenden Seite wiederholen.

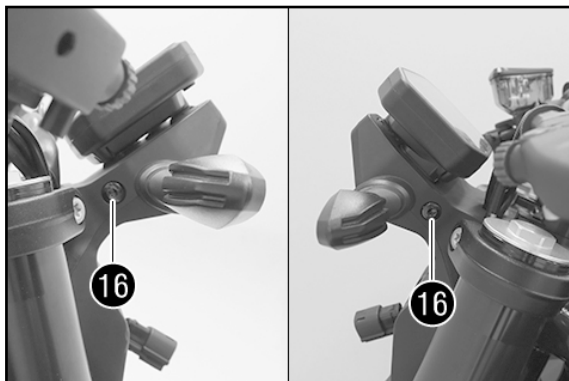

- Schrauben **16** montieren und mit 5 Nm festziehen.
- Schrauben **16** montieren und mit 5 Nm festziehen.
- Schrauben **14** montieren und mit 2 Nm festziehen.

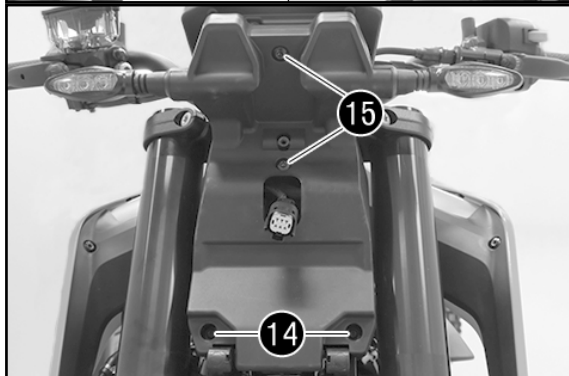

- Stecker **13** anstecken.
- Scheinwerfermaske positionieren.
- Einstellschraube **12** montieren.

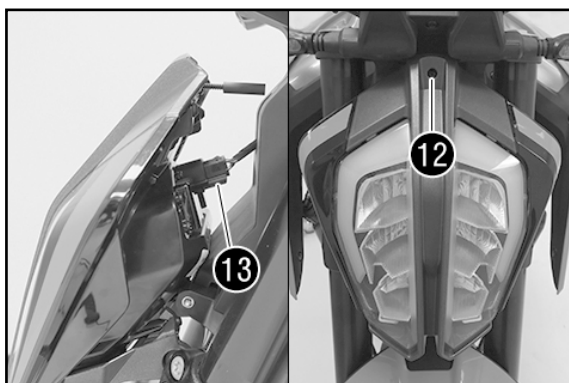

- Schrauben **11** montieren und mit 2 Nm festziehen.

### Nacharbeit

- Scheinwerfereinstellung kontrollieren (s. Bedienungsanleitung).
- Leuchtweite des Scheinwerfers einstellen (s. Bedienungsanleitung).

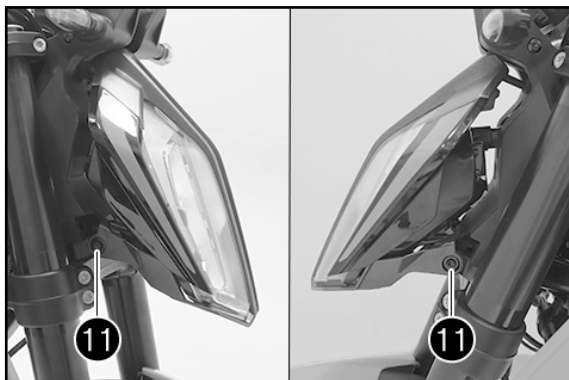

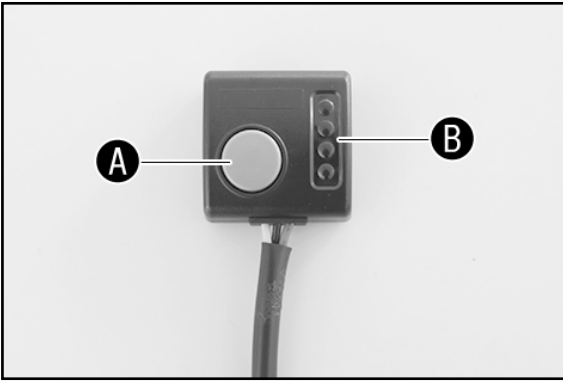

### Einschalten

- Taste **A** für ca. 3 Sekunden gedrückt halten.

✓ LED-Anzeige **B** zeigt die jeweilige Heizstufe an.

Grün = Stufe 1  
 Gelb = Stufe 2  
 Orange = Stufe 3  
 Rot = Stufe 4

### Ausschalten

- Taste **A** für ca. 3 Sekunden gedrückt halten.

✓ LED-Anzeige **B** ist aus.

### Heizstufe ändern

- Taste **A** drücken, um zwischen den verschiedenen Heizstufen zu wechseln.

### HINWEIS

Beim Ausschalten wird die zu diesem Zeitpunkt gewählte Heizstufe gespeichert und beim erneuten Einschalten wieder abgerufen.

### Schnellheizfunktion

Die Schnellheizfunktion arbeitet immer für 4 Minuten nach dem Einschalten. Während der Schnellaufheizung blinkt die LED der gespeicherten Stufe.

Die Schnellheizfunktion kann durch Drücken der Taste **A** abgebrochen werden.



## 790 Adventure

### Montage Heizgriffe

- Zündung ausschalten.
- Schrauben 11 entfernen.
- Beide Maskenspoiler entfernen.

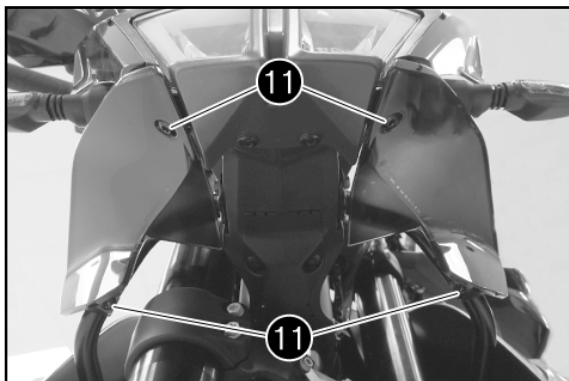

- Spreiznieten 12 entfernen und Abdeckung 13 aufklappen.
- Temperatursensor 14 aushängen.
- Abdeckung 13 entfernen.

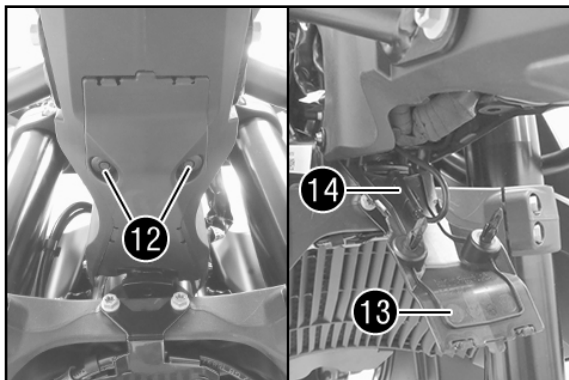

- Schrauben 15 lösen.
- Schrauben 16 entfernen.



- Schrauben 17 entfernen.
- Scheinwerfer nach vorn ziehen.

#### HINWEIS

Bauteile durch Abdecken vor Beschädigungen schützen.

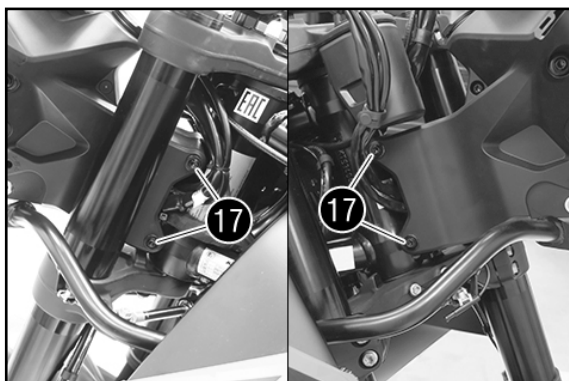

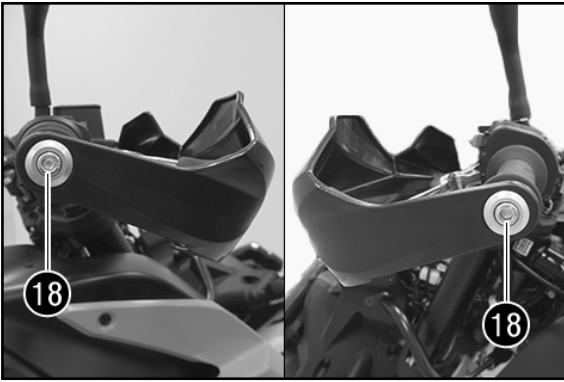

- Schrauben 18 lösen.

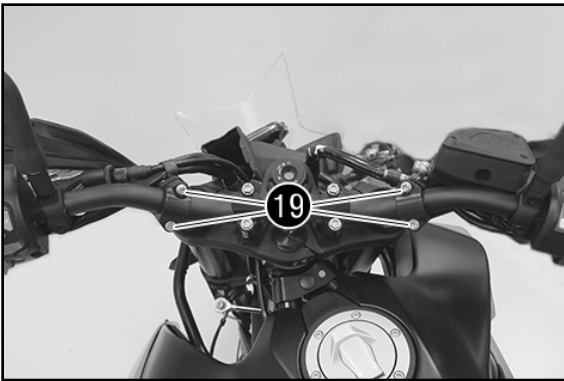

- Schraubverbindungen 19 entfernen.  
- Handschützer und Lenkergewichte entfernen.

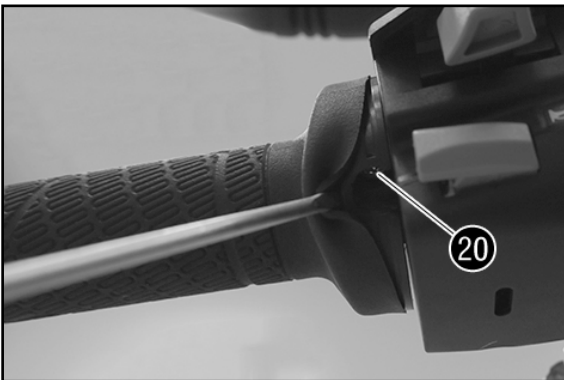

#### Linke Seite

- Griffgummi leicht anheben.  
- Schraube 20 lösen.  
- Festgriff entfernen.

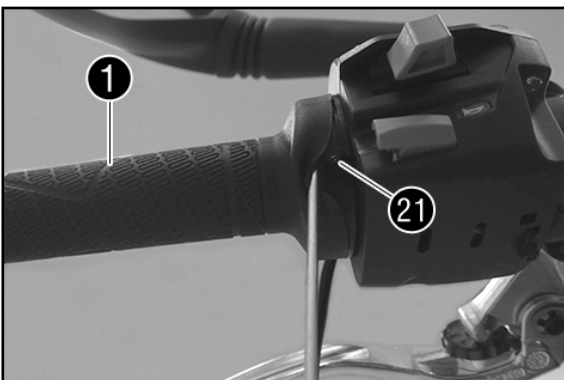

- Heizgriff links 1 (Lieferumfang) am Lenker positionieren.  
- Griffgummi leicht anheben.  
- Vormontierte Schraube 21 festziehen.



#### Rechte Seite

- Schrauben 22 entfernen.  
- Abdeckung abnehmen.  
- Gasdrehgriff vom Lenker ziehen.

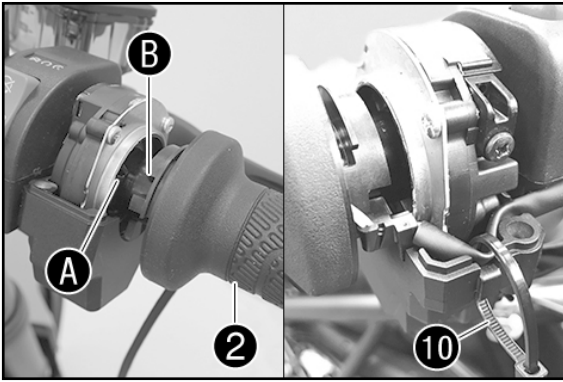

- Heizgriff rechts ② (Lieferumfang) am Lenker positionieren.

✓ Die Nase ④ greift im Mitnehmer ③ ein.

- Kabel im Gasdrehgriffsensor spannungsfrei verlegen (wie dargestellt) und mit Kabelbinder ⑩ (Lieferumfang) sichern.

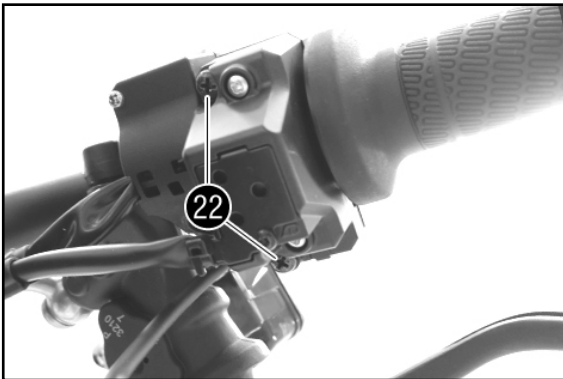

- Abdeckung positionieren.

### ! VORSICHT

Sicher stellen, dass das Kabel nicht geknickt oder geklemmt werden kann!

- Original-Schrauben ②② montieren und mit 3,5 Nm festziehen.



### Kabelverlegung

- Kabel der Heizgriffe beidseitig entlang der vorhandenen Kabel zur Scheinwerfermaske verlegen.

- Steckerverbindung ②③ der beiden Heizgriffe zusammenstecken.

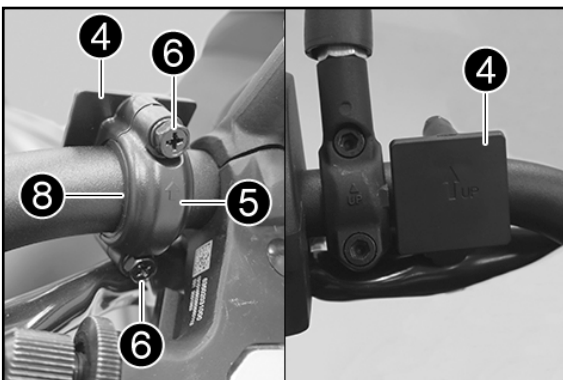

### Montage Steuereinheit

- Halterung oben ④ und unten ⑤ mit Gummischutz ③ (alles Lieferumfang) an der gewünschten Lenkerseite positionieren.

- Schrauben ⑥ mit Sprengringen ⑦ (alles Lieferumfang) montieren und mit 2 Nm festziehen.

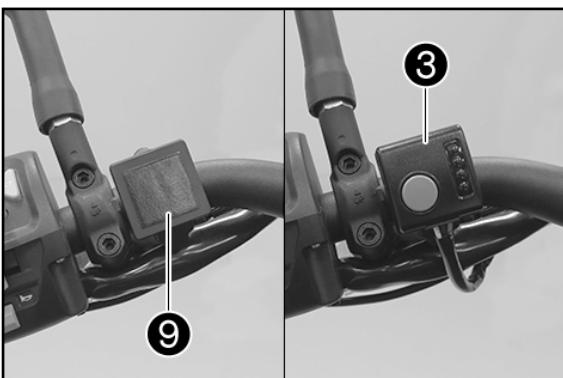

- Doppelseitiges Klebeband ⑨ (Lieferumfang) auf die Halterung kleben.

- Steuereinheit ③ aufkleben und ggf. mit Kabelbindern ⑩ (Lieferumfang) sichern.



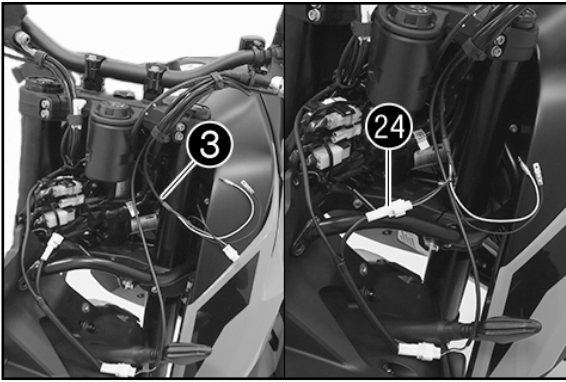

- Kabelstrang der Steuereinheit ③ entlang der vorhandenen Kabel zur Scheinwerfermaske verlegen.
- Steckerverbindung ②④ zusammenstecken.

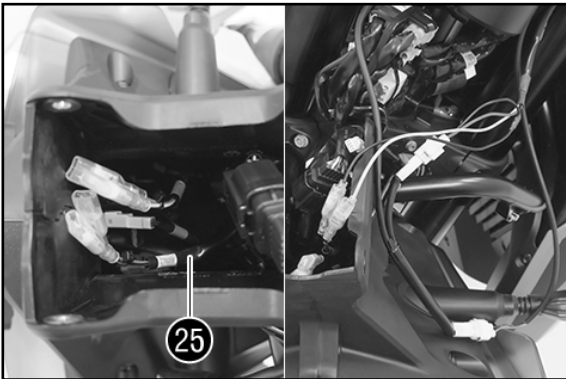

- Kabelstrang ACC2 ②⑤ aus der Scheinwerfermaske ausfädeln.
- Kabelstrang der Steuereinheit den Farben entsprechend an ACC2 anstecken.

**HINWEIS**

Auf den Kabeln befindet sich ein Aufkleber mit der Aufschrift ACC1 und ACC2.

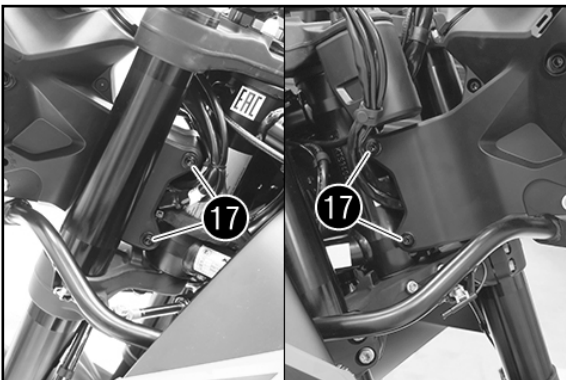

**Zusammenbau**

- Scheinwerfermaske positionieren.

**HINWEIS**

Kabel ordnungsgemäß verlegen und sicherstellen, dass die Kabel nicht geknickt oder geklemmt werden.

- Schrauben ①⑦ montieren und mit 10 Nm (Loctite 243) festziehen.

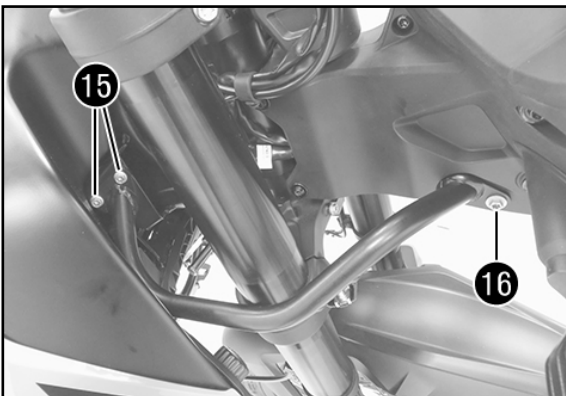

- Schrauben ①⑥ montieren und mit 10 Nm (Loctite 243) festziehen.
- Schrauben ①⑤ mit 10 Nm festziehen.



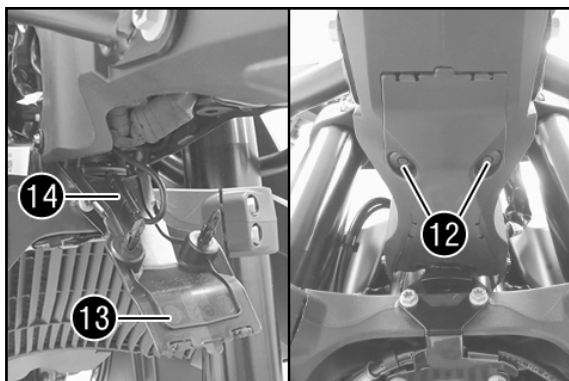

- Abdeckung 13 positionieren.
- Temperatursensor 14 einhängen.
- Abdeckung mit Spreiznieten 12 montieren.

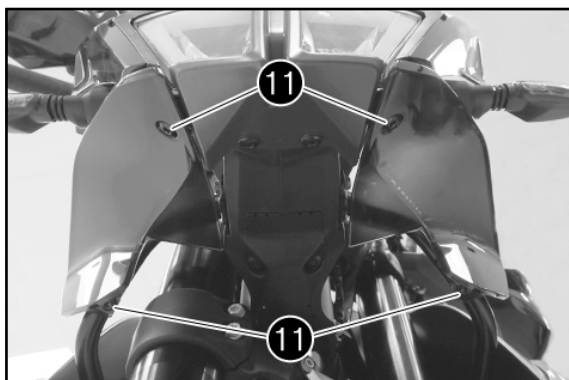

- Maskenspoiler positionieren.
- Schrauben 11 montieren und mit 3 Nm festziehen.

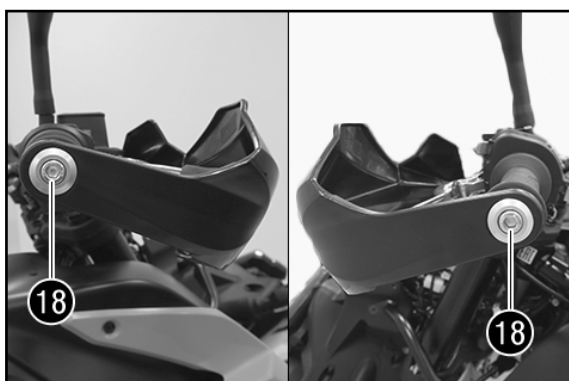

- Handschützer mit Lenkergewicht positionieren.
- Schraube 18 mit 25 Nm festziehen.



- Handschützer am Lenker positionieren.
- Schraubverbindungen 19 montieren und mit 6 Nm festziehen.

#### Nacharbeit

- Scheinwerfereinstellung kontrollieren (s. Bedienungsanleitung).



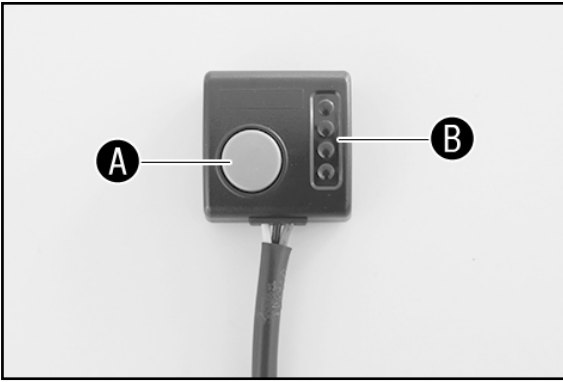

### Einschalten

- Taste **A** für ca. 3 Sekunden gedrückt halten.
- ✓ LED-Anzeige **B** zeigt die jeweilige Heizstufe an.

Grün = Stufe 1  
 Gelb = Stufe 2  
 Orange = Stufe 3  
 Rot = Stufe 4

### Ausschalten

- Taste **A** für ca. 3 Sekunden gedrückt halten.
- ✓ LED-Anzeige **B** ist aus.

### Heizstufe ändern

- Taste **A** drücken, um zwischen den verschiedenen Heizstufen zu wechseln.

### HINWEIS

Beim Ausschalten wird die zu diesem Zeitpunkt gewählte Heizstufe gespeichert und beim erneuten Einschalten wieder abgerufen.

### Schnellheizfunktion

Die Schnellheizfunktion arbeitet immer für 4 Minuten nach dem Einschalten. Während der Schnellaufheizung blinkt die LED der gespeicherten Stufe.

Die Schnellheizfunktion kann durch Drücken der Taste **A** abgebrochen werden.

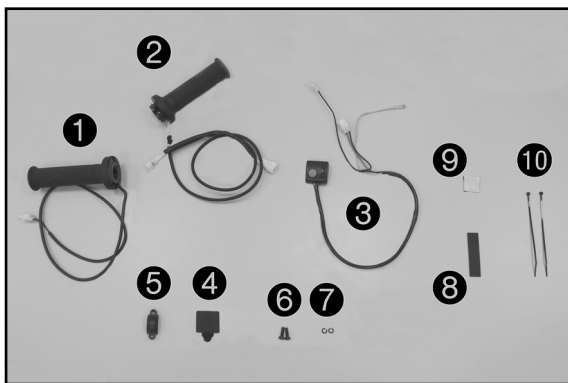

**Scope of supply**

- 1x heated grip, left ①
- 1x heated grip, right ②
- 1x heated grip, control unit ③
- 1x upper bracket ④
- 1x lower bracket ⑤
- 2x screw M5x15 ⑥
- 2x circlip ⑦
- 1x rubber protector ⑧
- 1x double-sided adhesive tape ⑨
- 2x cable tie ⑩

**790 Duke**

**Mounting heated grip**

- Switch off the ignition system.
- Remove screws ⑪.

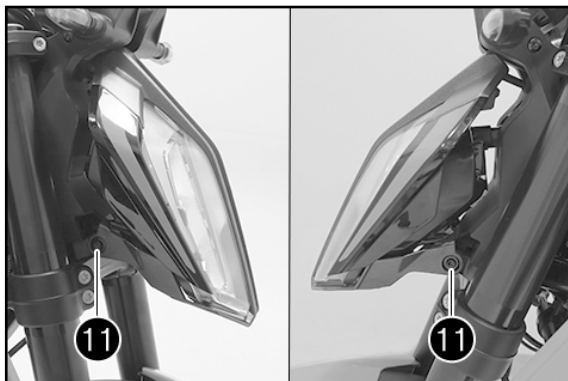

- Completely unscrew adjusting screw ⑫.

**NOTE**

The adjusting screw is fastened to the headlight mask by a ball head holder.  
Do not pull the adjusting screw out of the ball head holder.

- Swivel the headlight mask slightly forwards and disconnect socket connector ⑬.
- Remove the headlight.

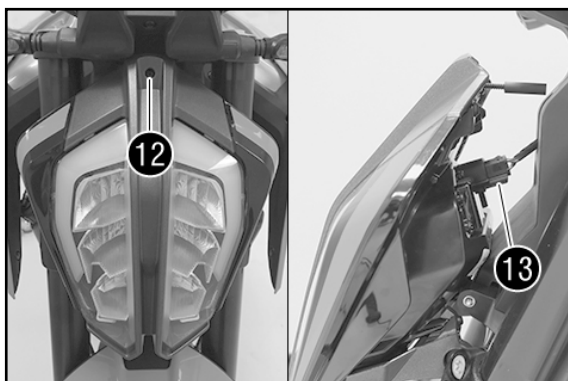

- Remove screws ⑭.
- Remove screws ⑮.
- Remove screws ⑯.

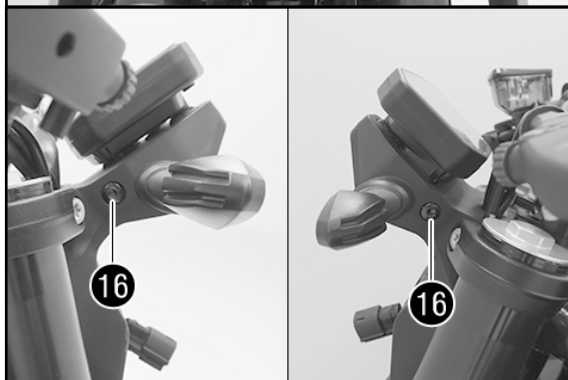
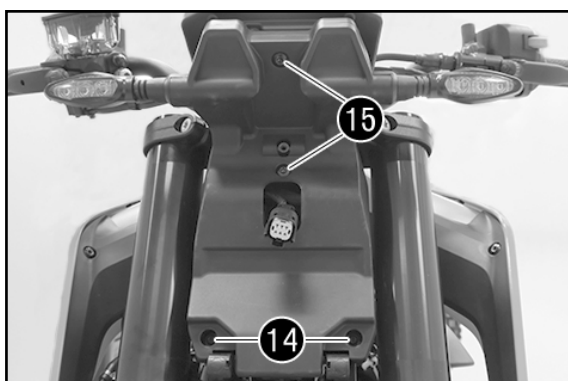

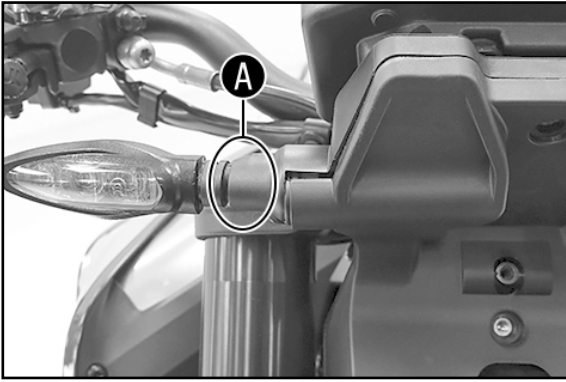

- Hold turn signal in the area **A** and carefully press against to the direction of travel.

✓ The cover is detached as illustrated.

- Repeat the operation on the opposite side.  
- Remove the cover.

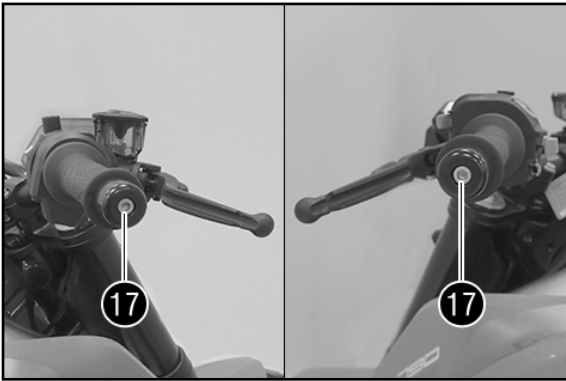

- Loosen screws **17** and remove handlebar weight.

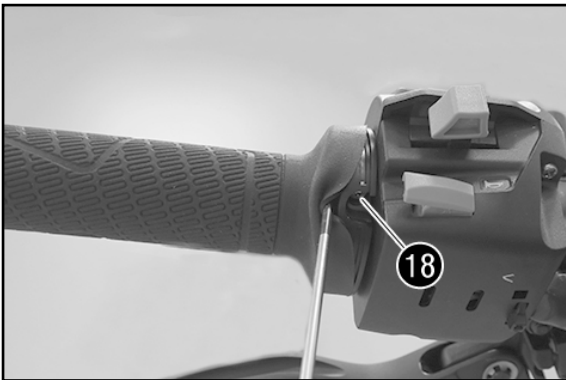

**Left-hand side**

- Slightly raise the hand grip.  
- Loosen screw **18**.  
- Remove fixed grip.

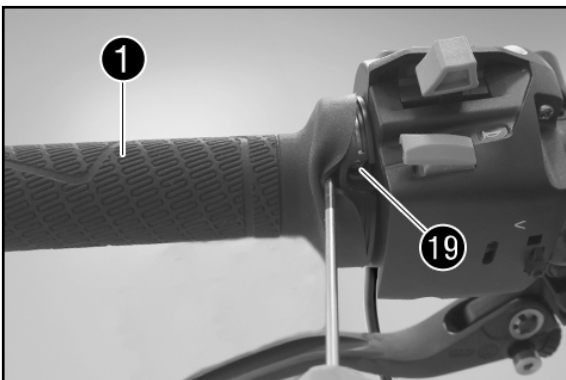

- Position left heated grip **1** (included) on the handlebar.  
- Slightly raise the hand grip.  
- Tighten screw **19**.

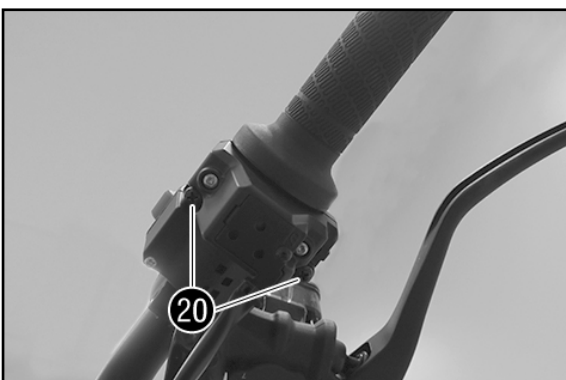

**Right-hand side**

- Remove screws **20**.  
- Take off the cover.  
- Pull throttle from handlebar.

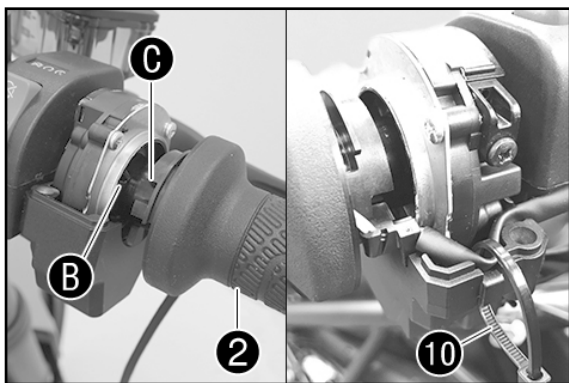

- Position right heated grip ② (included) on the handlebar.

✓ Catch ③ engages in driver ④.

- Route the cable in the accelerator position sensor so it is not under tension (as shown) and secure with a cable tie ⑩ (included).

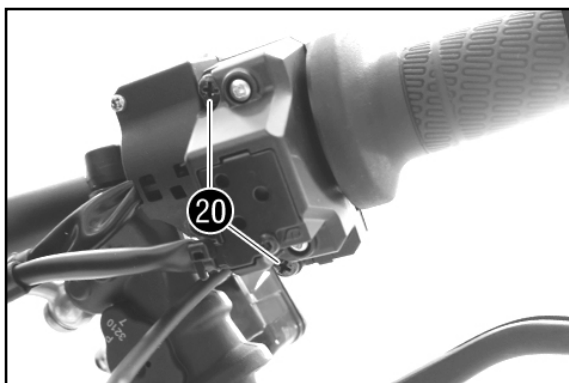

- Position the cover.

### ! ATTENTION

Ensure that the cable can neither be kinked or pinched!

- Mount original screws ⑳ and tighten to 3.5 Nm.

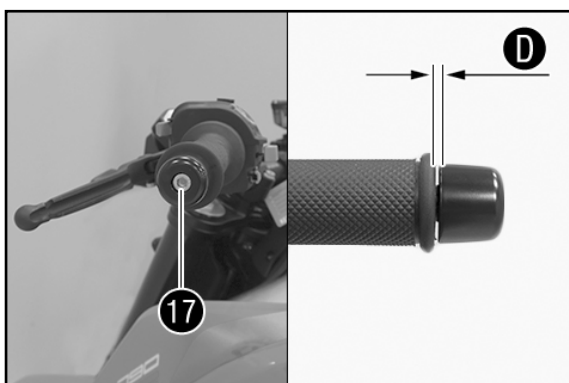

- Mount left handlebar weight and tighten screw ⑰ to 10 Nm.

- Position right handlebar weight with a spacing of ① (2 mm) and tighten screw ⑰ to 10 Nm.

#### NOTE

Observe spacing to prevent the throttle from getting stuck.

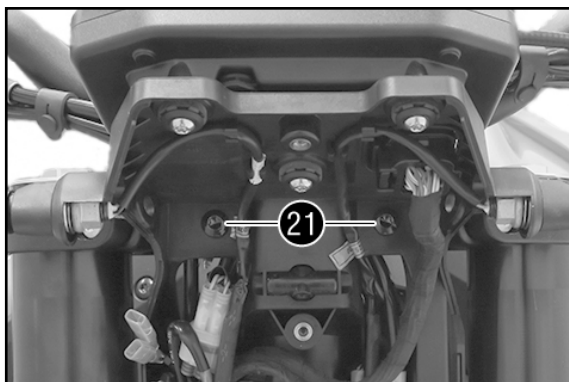

#### Cable routing

- Remove screws ⑳.

- Pull the cover slightly forward.



- Route the cable of the heated grip on both sides along the existing cables to the headlight mask.

- Join plug-in connector ㉒.



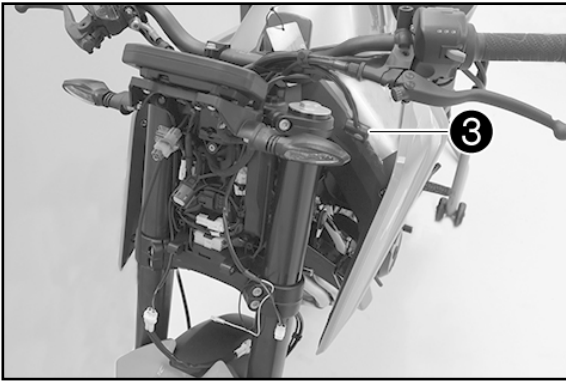

**Mounting control unit**

- Route the wiring harness of the control unit ③ (included) from the desired half of the handlebar along the existing cables to the headlight mask.

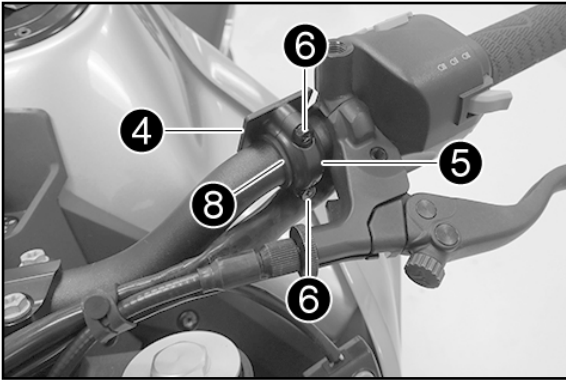

- Position upper bracket ④ and lower bracket ⑤ using rubber protector ⑧ (all included).
- Mount screws ⑥ with circlips ⑦ (all included) and tighten to 2 Nm.

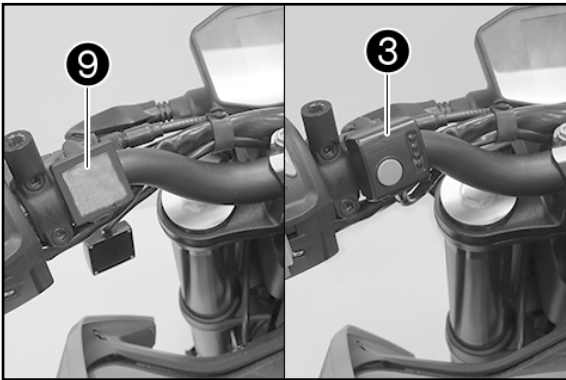

- Stick double-sided adhesive tape ⑨ (included) to the upper bracket ④.
- Stick on control unit ③ and if necessary secure with cable ties ⑩ (included).

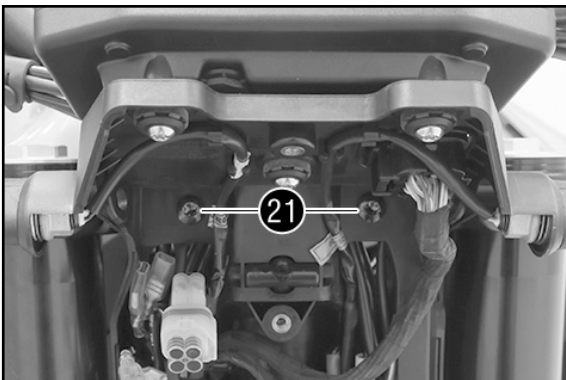

- Position cover, mount screws ⑳ and tighten to 5 Nm.

**! ATTENTION**  
**Ensure that the cable can neither be kinked or pinched!**

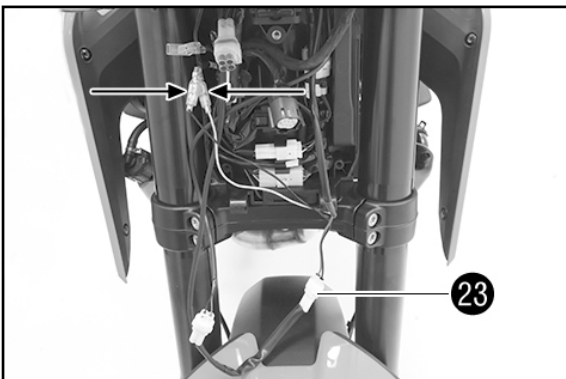

- Join plug-in connector ㉓.
- Connect control unit wiring harness to ACC2 of the vehicle wiring harness.

**NOTE**  
 The cables have an adhesive sticker marked ACC 2.

- Route the cable without tension and if necessary secure with a cable ties.



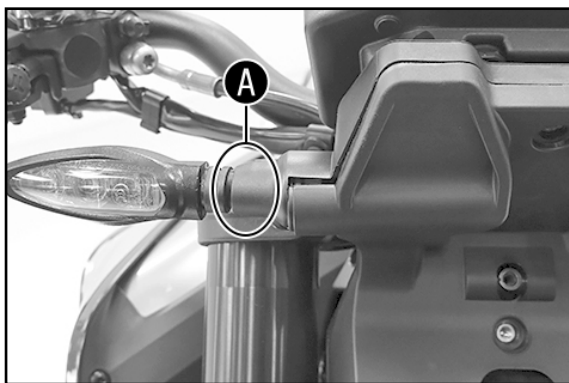

### Assembling

- Position cover, guiding the headlight plug-in connector through the opening in the process.
- Hold turn signal in the area **A** and carefully press against the direction of travel, while pressing the cover tight at the same time.
- ✓ The cover engages with an audible click.
- Repeat the operation on the opposite side.

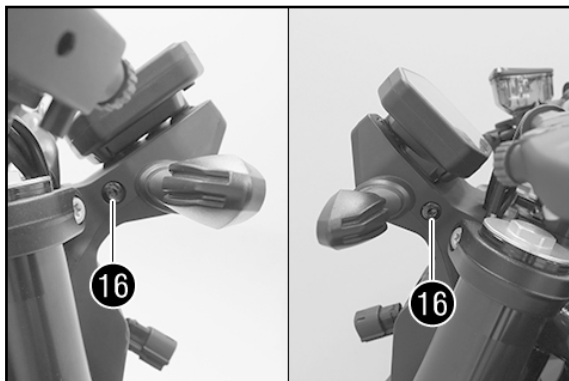

- Mount screws **16** and tighten to 5 Nm.
- Mount screws **15** and tighten to 5 Nm.
- Mount screws **14** and tighten to 2 Nm.

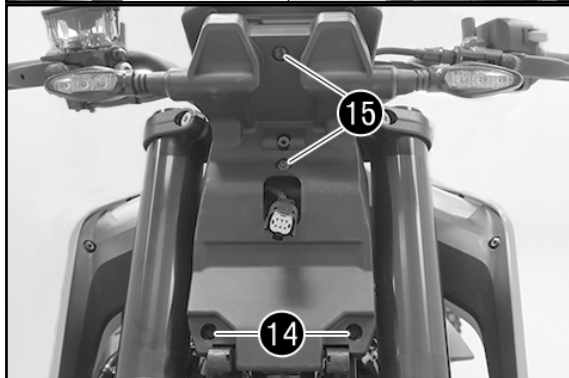

- Plug in socket connector **13**.
- Position the headlight mask.
- Mount adjusting screw **12**.

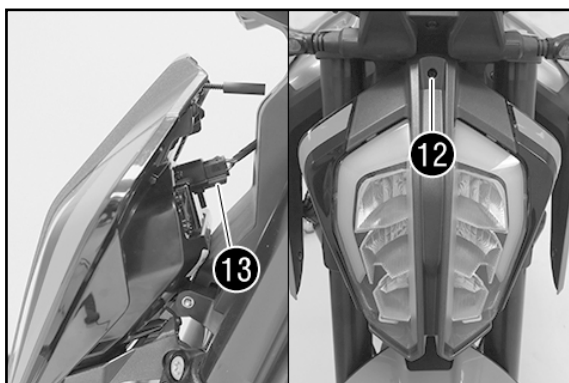

- Mount screws **11** and tighten to 2 Nm.

### Final steps

- Check headlight setting (see owner's manual).
- Adjust headlight range of the headlight (see owner's manual).

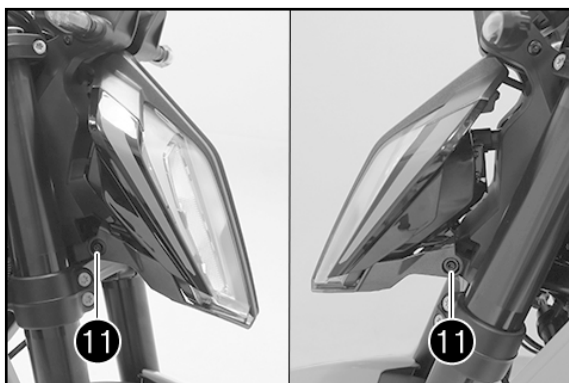

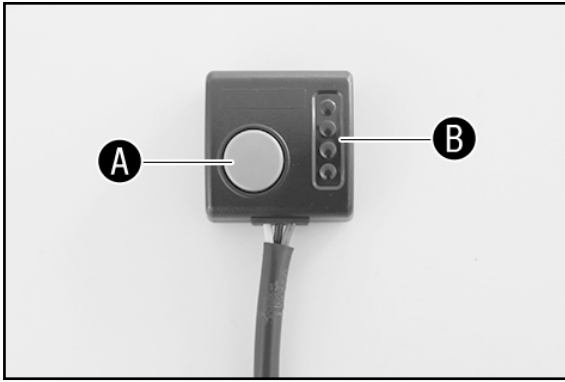

### Switching on

- Press and hold button **A** for approximately 3 seconds.

✓ LED indicator **B** displays the corresponding heating level.

Green = level 1  
 Yellow = level 2  
 Orange = level 3  
 Red = level 4

### Switching off

- Press and hold button **A** for approximately 3 seconds.

✓ LED indicator **B** turns off.

### Changing heating level

- Press button **A** to change between the various heating levels.

#### NOTE

When switching off, the heating level selected at the time will be saved and called up when switching on again.

### Quick heating function

The quick heating function is always active for 4 minutes after switching on. During quick heating, the LED of the saved level flashes.

The quick heating function can be canceled by pressing the button **A**.

## 790 Adventure

### Mounting the heated grip

- Switch off the ignition system.
- Remove screws 11.
- Remove both the mask spoilers.

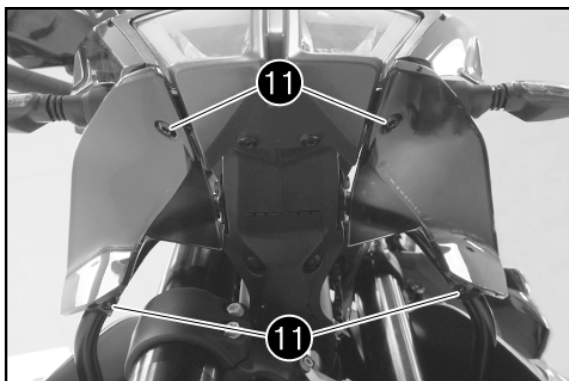

- Remove expanding rivets 12 and open cover 13.
- Detach temperature sensor 14.
- Remove cover 13.

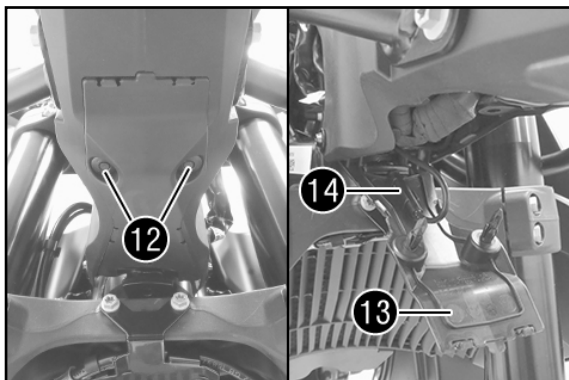

- Loosen screws 15.
- Remove screws 16.

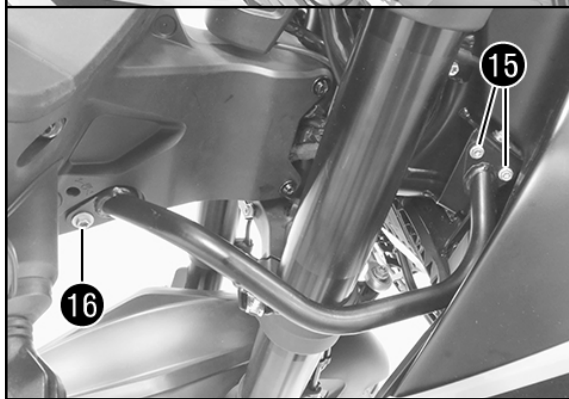
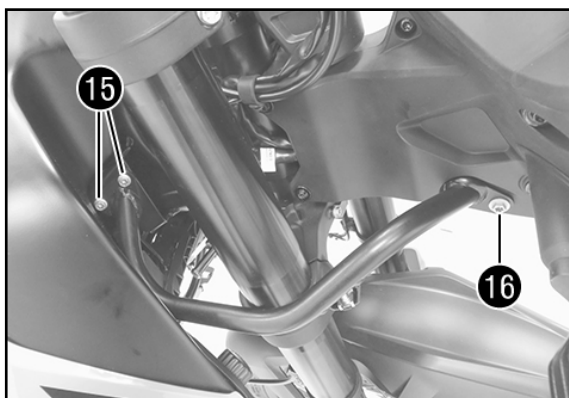

- Remove screws 17.
- Pull the headlight forward.

**NOTE**

Cover the components to protect them against damage.

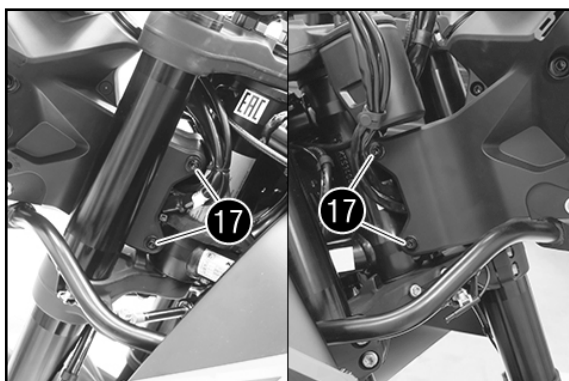

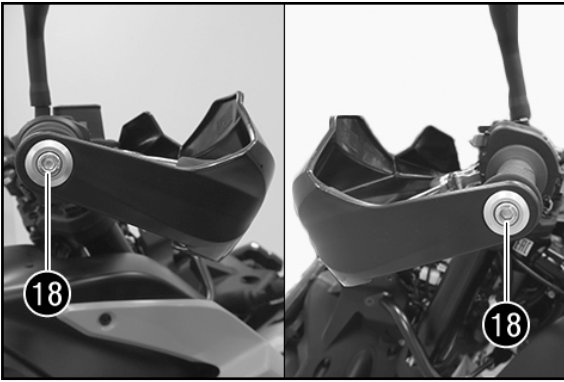

- Loosen screws 18.

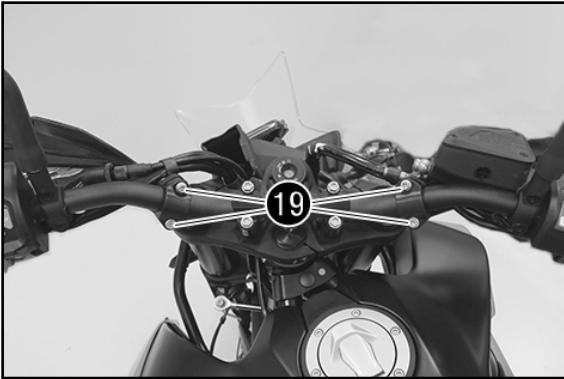

- Remove screw connections 19.
- Remove handguards and handlebar weights.

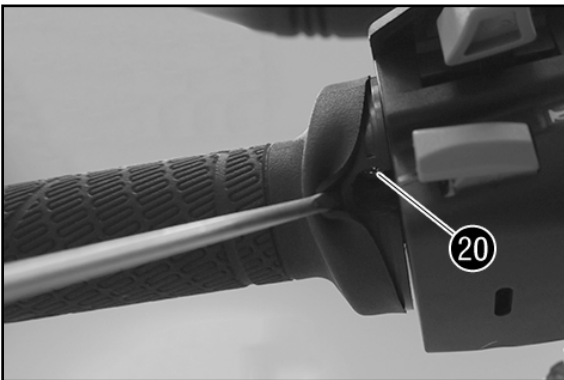

**Left-hand side**

- Slightly raise the hand grip.
- Loosen screw 20.
- Remove fixed grip.

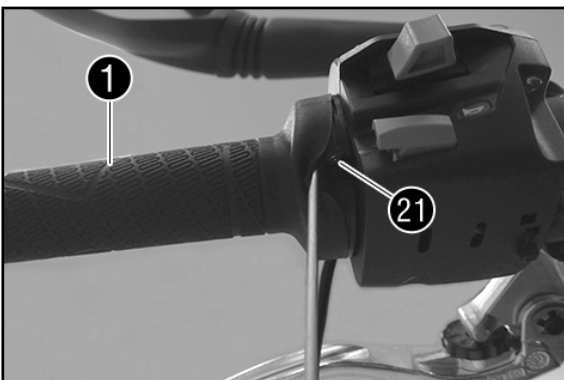

- Position left heated grip 1 (included) on the handlebar.
- Slightly raise the hand grip.
- Tighten preassembled screw 21.



**Right-hand side**

- Remove screws 22.
- Take off the cover.
- Pull throttle from handlebar.



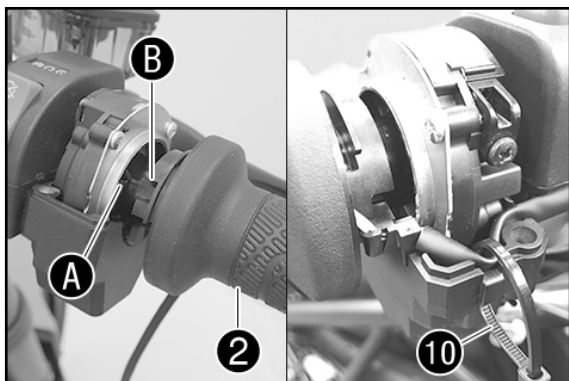

- Position right heated grip ② (included) on the handlebar.

✓ Catch ① engages in inner clutch hub ②.

- Route the cable in the accelerator position sensor so it is not under tension (as shown) and secure with cable tie ⑩ (included).

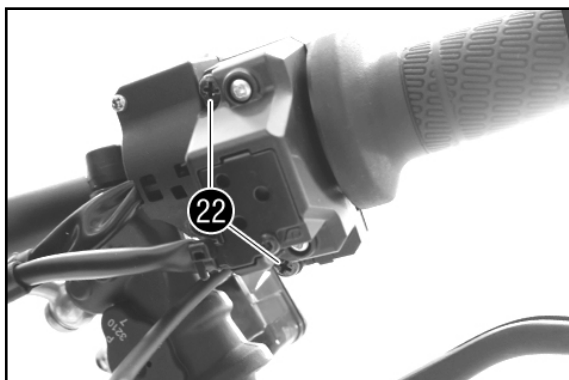

- Position the cover.

### ! ATTENTION

Ensure that the cable can be neither kinked or pinched!

- Mount original screws ⑫ and tighten to 3.5 Nm.



### Cable routing

- Route the cable of the heated grip on both sides along the existing cables to the headlight mask.

- Join plug-in connector ⑬ of the two heated grips.

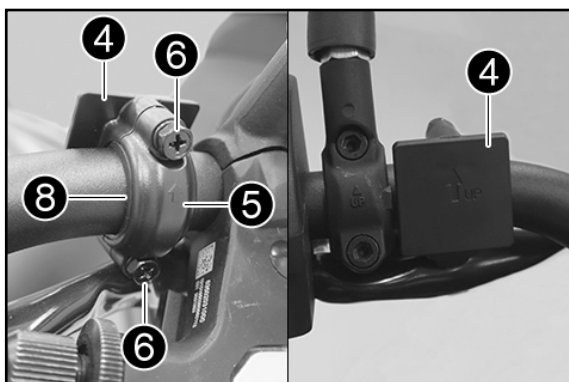

### Mounting the control unit

- Position upper bracket ④ and lower bracket ⑤ using rubber protector ③ (all included) on the desired half of the handlebar.

- Mount screws ⑥ with circlips ⑦ (all included) and tighten to 2 Nm.

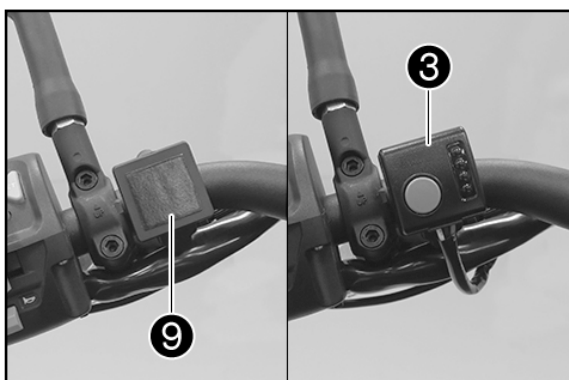

- Stick double-sided adhesive tape ⑨ (included) to the bracket.

- Stick on control unit ③ and if necessary secure with cable ties ⑩ (included).



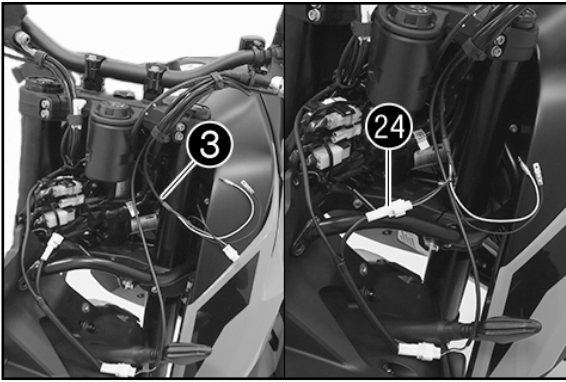

- Route control unit wiring harness ③ along the existing cables to the headlight mask.

- Join plug-in connector ②④.

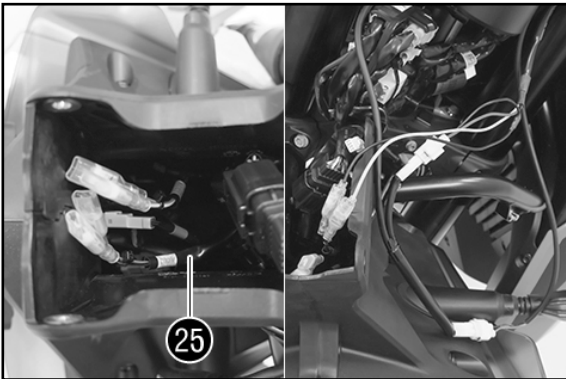

- Slip out wiring harness ACC2 ②⑤ from the headlight mask.

- Plug in control unit wiring harness to ACC2, according to the colors.

**NOTE**

There is a sticker labeled ACC1 and ACC2 on the cables.

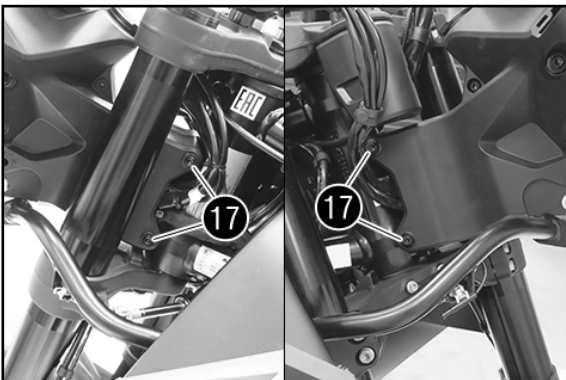

**Assembling**

- Position the headlight mask.

**NOTE**

Route cable correctly and ensure that the cable is not bent or wedged.

- Mount screws ①⑦ and tighten to 10 Nm (Loctite 243).

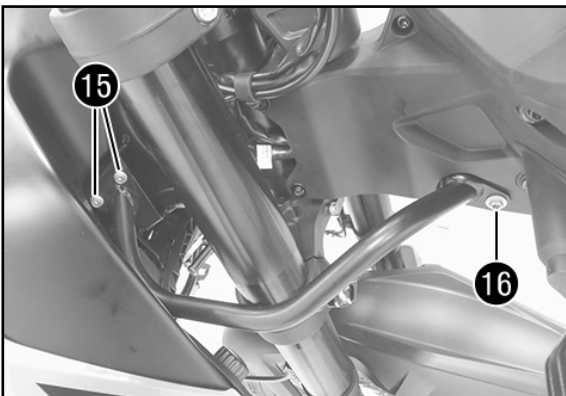

- Mount screws ①⑥ and tighten to 10 Nm (Loctite 243).

- Tighten screws ①⑤ to 10 Nm.



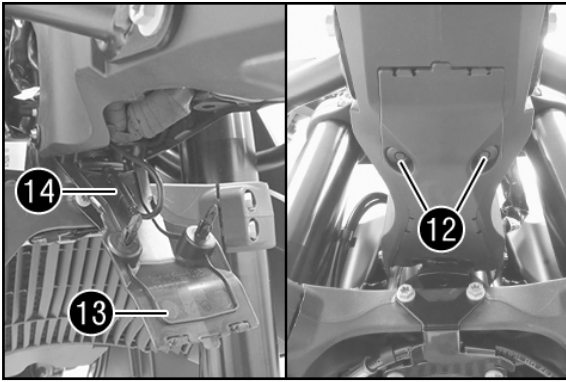

- Position cover 13.
- Attach temperature sensor 14.
- Mount the cover with expanding rivets 12.

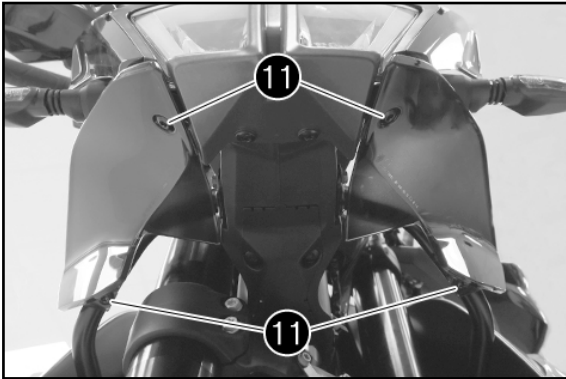

- Position the mask spoiler.
- Mount screws 11 and tighten to 3 Nm.

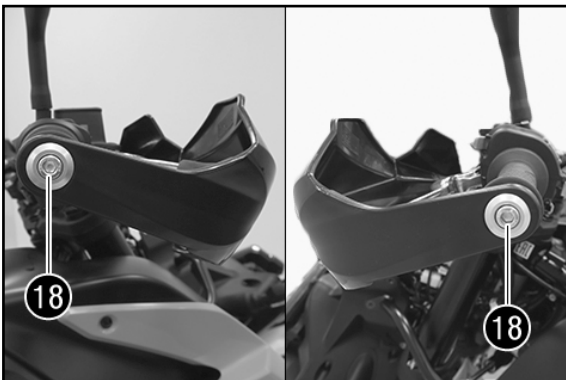

- Position handguard with handlebar weight.
- Tighten screw 18 to 25 Nm.



- Position the handguard on the handlebar.
- Mount screw connections 19 and tighten to 6 Nm.

#### Final steps

- Check headlight setting (see Owner's Manual).

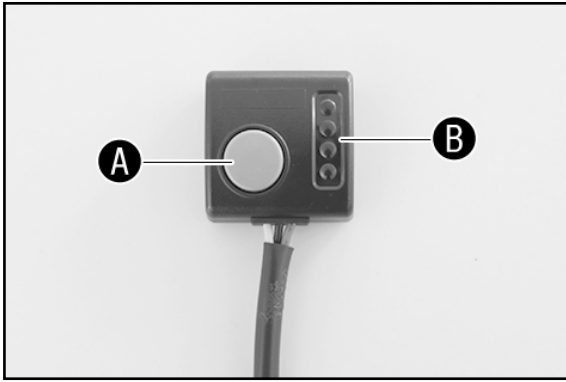

### Switching on

- Press and hold button **A** for approximately 3 seconds.

✓ LED indicator **B** displays the corresponding heating level.

Green = level 1  
 Yellow = level 2  
 Orange = level 3  
 Red = level 4

### Switching off

- Press and hold button **A** for approximately 3 seconds.

✓ LED indicator **B** turns off.

### Changing heating level

- Press button **A** to change between the various heating levels.

#### NOTE

When switching off, the heating level selected at the time will be saved and called up when switching on again.

### Quick heating function

The quick heating function is always active for 4 minutes after switching on. During quick heating, the LED of the saved level flashes.

The quick heating function can be canceled by pressing button **A**.

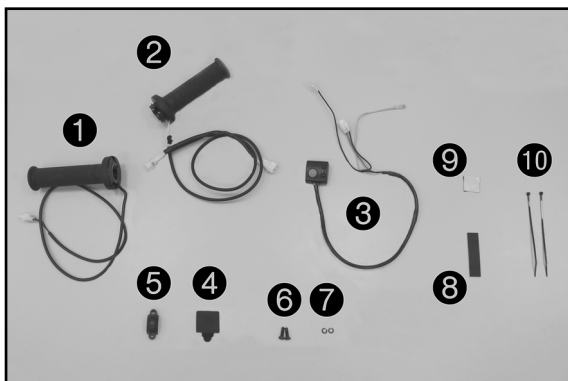

## Materiale fornito

- 1 manopola riscaldabile sinistra ❶
- 1 manopola riscaldabile destra ❷
- 1 manopola riscaldabile centralina ❸
- 1 supporto superiore ❹
- 1 supporto inferiore ❺
- 2 viti M5x15 ❻
- 2 anelli (elastici) di sicurezza ❼
- 1 protezione in gomma ❽
- 1 nastro biadesivo ❾
- 2 fascette serracavi ❿

## 790 Duke

### Montaggio manopole riscaldabili

- Disinserire l'accensione.
- Rimuovere le viti ❶.

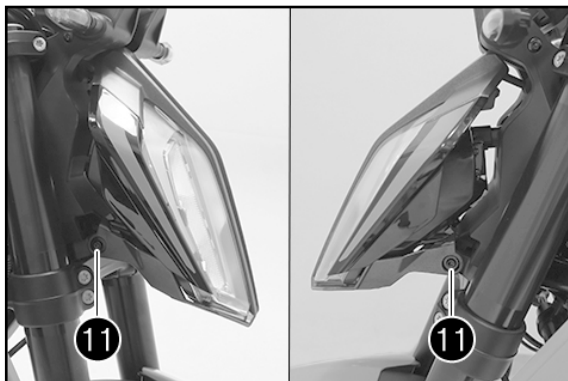

- Svitare completamente la vite di regolazione ❷.

### AVVERTENZA

La vite di regolazione è fissata alla mascherina portafaro per mezzo di un supporto a testa sferica. Non estrarre la vite di regolazione dal supporto a testa sferica.

- Ruotare la mascherina portafaro leggermente in avanti e scollegare il connettore ❸.
- Rimuovere il faro.

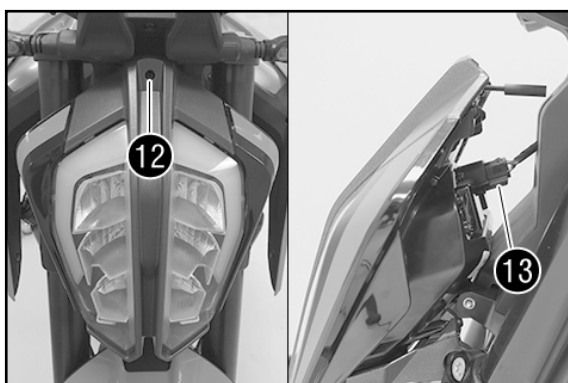

- Rimuovere le viti ❹.
- Rimuovere le viti ❺.
- Rimuovere le viti ❻.

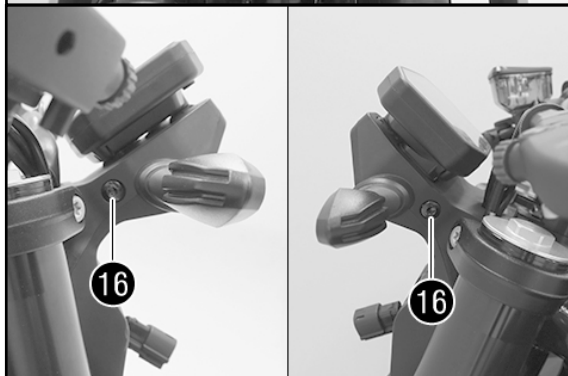
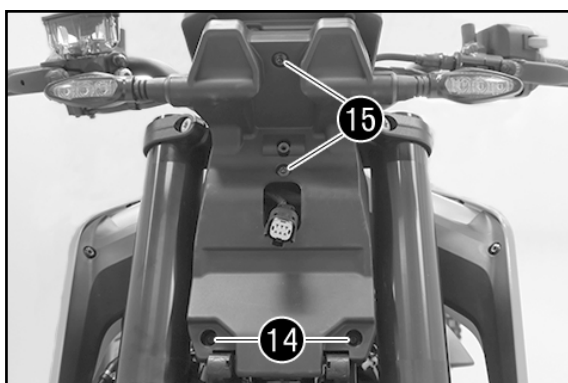



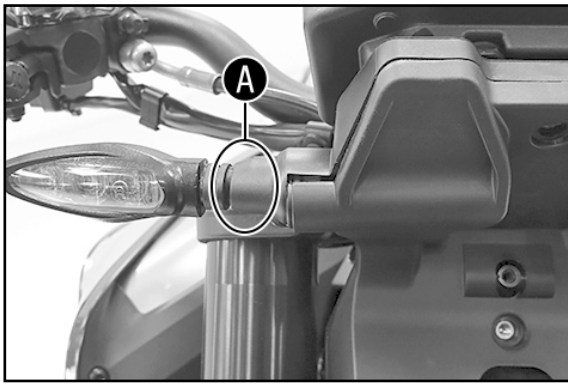

- Afferrare l'indicatore di direzione nella zona **A** e spingerlo con cautela in senso opposto alla direzione di marcia.

✓ La copertura si sgancia come si vede in figura.

- Ripetere la fase di lavoro sul lato opposto.  
- Rimuovere la copertura.

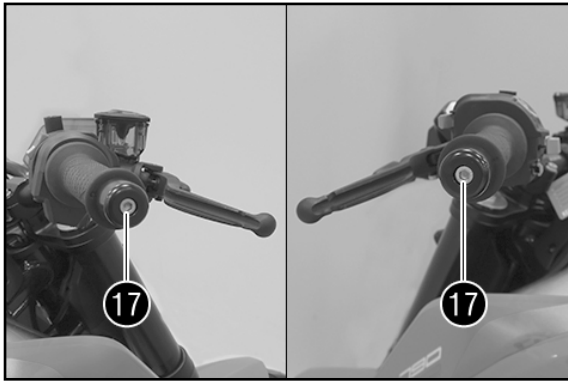

- Svitare le viti **17** e rimuovere il contrappeso del manubrio.

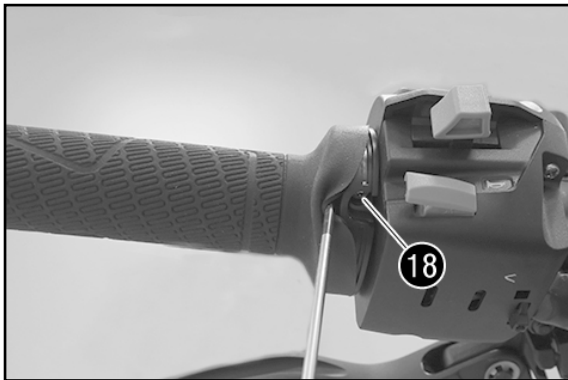

#### Lato sinistro

- Sollevare leggermente la manopola in gomma.  
- Svitare la vite **18**.  
- Rimuovere la manopola fissa.

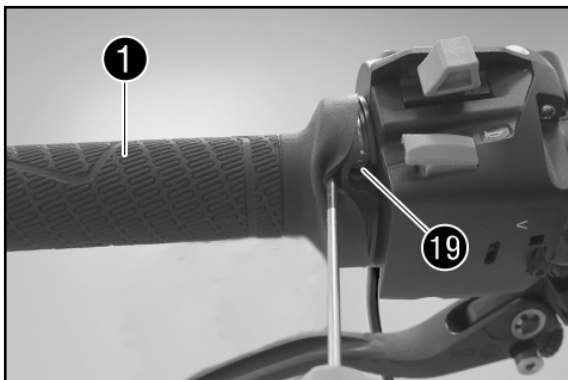

- Posizionare la manopola riscaldabile sinistra **1** (in dotazione) sul manubrio.  
- Sollevare leggermente la manopola in gomma.  
- Serrare la vite **19**.

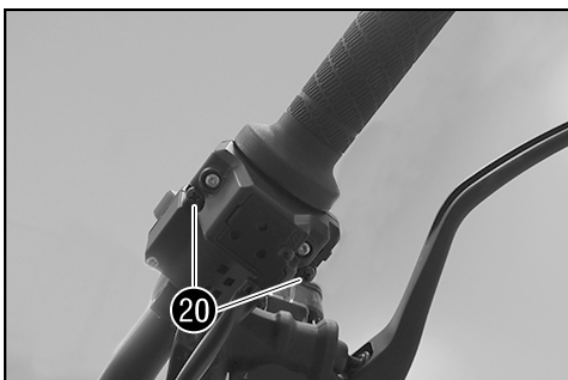

#### Lato destro

- Rimuovere le viti **20**.  
- Rimuovere la copertura.  
- Staccare la manopola dell'acceleratore dal manubrio.

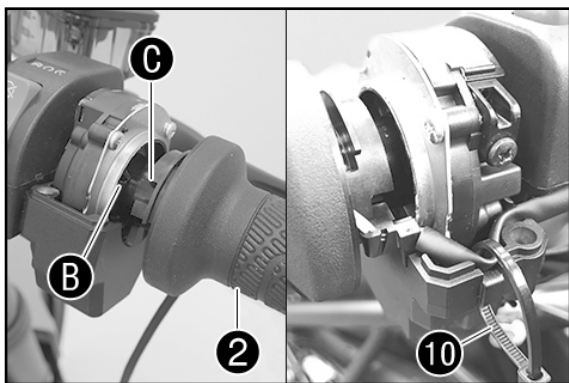

- Posizionare la manopola riscaldabile destra ② (in dotazione) sul manubrio.

✓ Il nasello ⑥ si innesta nel mozzetto della frizione ③.

- Posizionare il cavo sul sensore manopola dell'acceleratore in modo da non metterlo in tensione (come mostrato) e assicurarlo con una fascetta ⑩ (in dotazione).

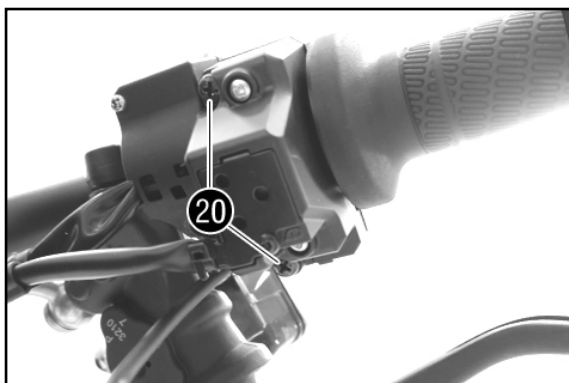

- Posizionare il coperchio.

### ! AVVERTIMENTO

Assicurarsi che il cavo non rischi di venire piegato o bloccato in qualche modo!

- Montare le viti originali ⑳ e serrarle a 3,5 Nm.

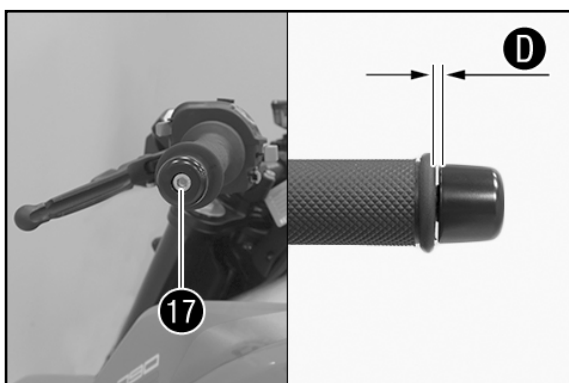

- Montare il contrappeso del manubrio a sinistra e serrare la vite ⑰ a 10 Nm.

- Posizionare il contrappeso del manubrio a destra alla distanza ① (2 mm) e serrare la vite ⑰ a 10 Nm.

### AVVERTENZA

Rispettare la distanza per impedire il bloccaggio della manopola dell'acceleratore.

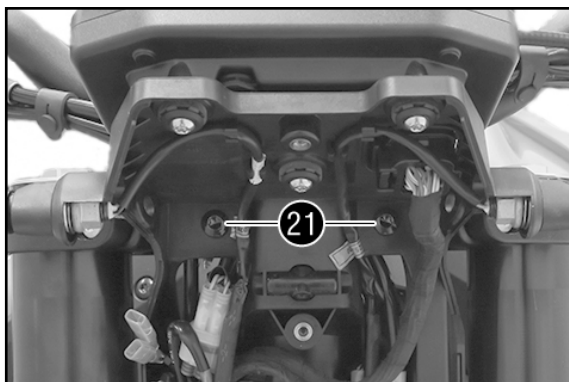

### Posa dei cavi

- Rimuovere le viti ㉑.  
- Tirare leggermente in avanti la copertura.



- Su entrambi i lati disporre i cavi delle manopole riscaldabili lungo i cavi presenti, portandoli verso la mascherina portafaro.  
- Collegare il connettore ㉒ delle due manopole riscaldabili.

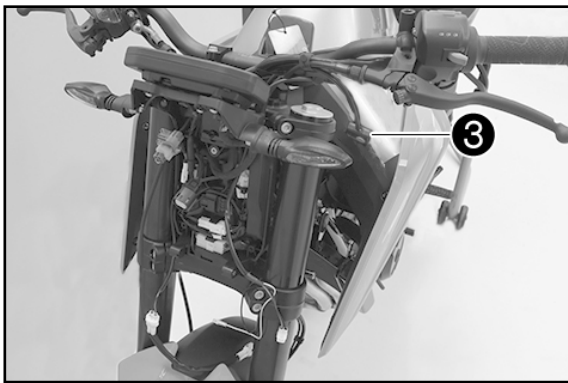

### Montaggio centralina

- Posare il cablaggio della centralina ③ (in dotazione), dalla parte del manubrio desiderata, lungo i cavi presenti verso la mascherina portafaro.

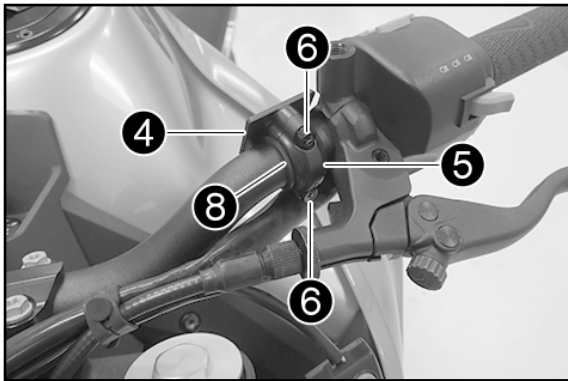

- Posizionare il supporto superiore ④ e inferiore ⑤ con protezione in gomma ⑧ (tutto in dotazione).  
- Montare le viti ⑥ con gli anelli (elastici) di sicurezza ⑦ (tutto in dotazione) e serrare a 2 Nm.

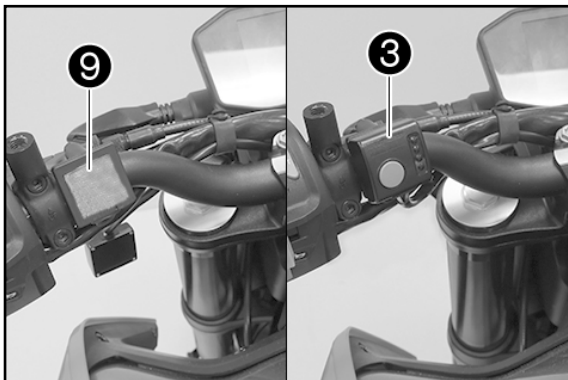

- Incollare il nastro biadesivo ⑨ (in dotazione) sul supporto superiore ④.  
- Incollare la centralina ③ ed eventualmente assicurarla con fascette serracavi ⑩ (in dotazione).

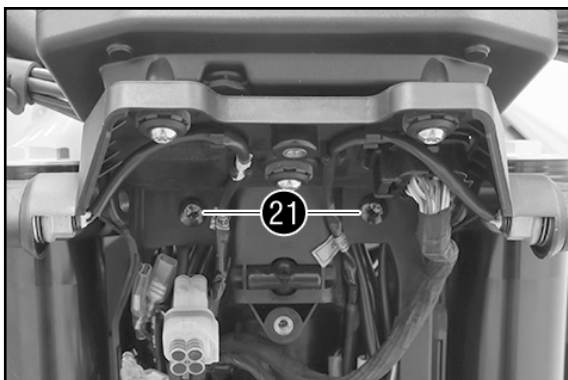

- Posizionare la copertura, montare le viti ⑪ e serrarle a 5 Nm.

### ! AVVERTIMENTO

**Assicurarsi che il cavo non rischi di venire piegato o bloccato in qualche modo!**

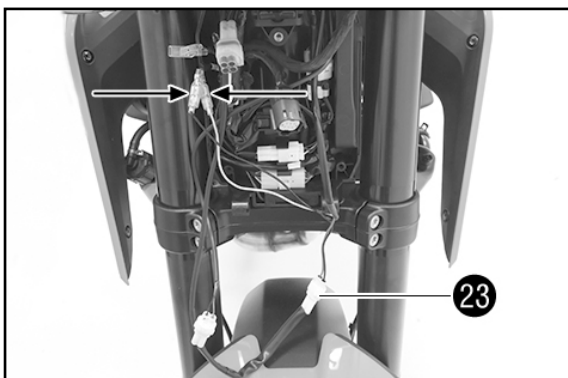

- Collegare il connettore ⑬.  
- Collegare il cablaggio della centralina all'attacco ACC2 del cablaggio del veicolo.

### AVVERTENZA

Sui cavi è presente un adesivo con la scritta ACC 2.

- Posizionare il cavo in modo che non sia in tensione ed eventualmente assicurarla con fascette serracavi.

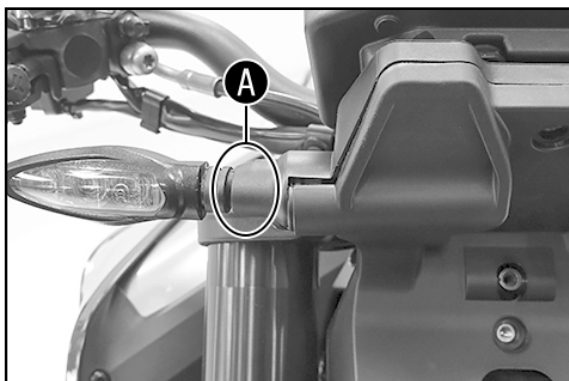

## Riassemblaggio

- Posizionare la copertura e far passare il connettore del faro attraverso l'apertura.
- Afferrare l'indicatore di direzione nella zona **A** e spingerlo con cautela in senso opposto alla direzione di marcia, contemporaneamente premere in sede la copertura.

✓ La copertura si innesta con un clic udibile.

- Ripetere la fase di lavoro sul lato opposto.

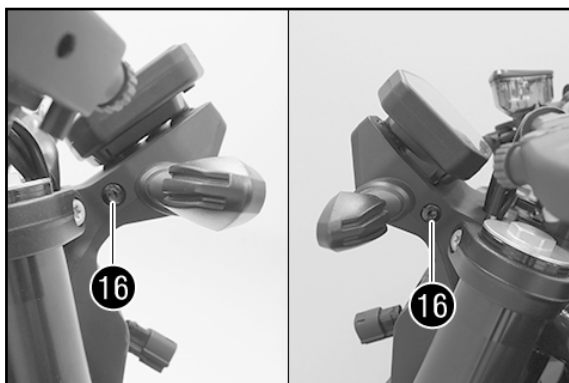

- Montare le viti **16** e serrarle a 5 Nm.
- Montare le viti **15** e serrarle a 5 Nm.
- Montare le viti **14** e serrarle a 2 Nm.

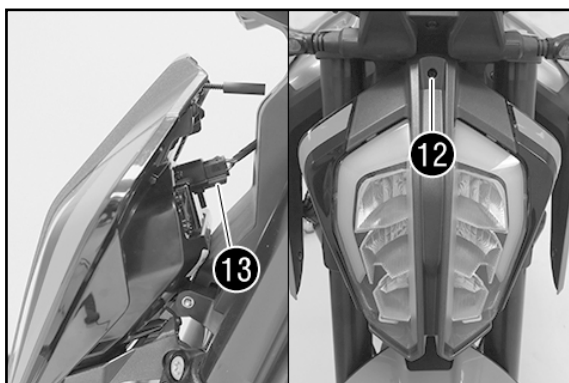
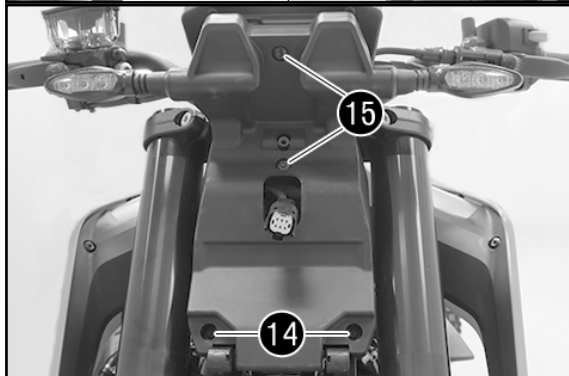

- Collegare il connettore **13**.
- Posizionare la mascherina portafaro.
- Montare la vite di regolazione **12**.

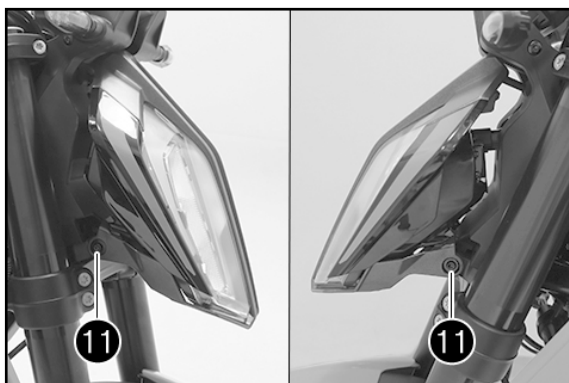

- Montare le viti **11** e serrarle a 2 Nm.

## Operazione conclusiva

- Controllare l'orientamento del faro (v. manuale d'uso).
- Regolare la profondità del fascio luminoso del faro (v. manuale d'uso).



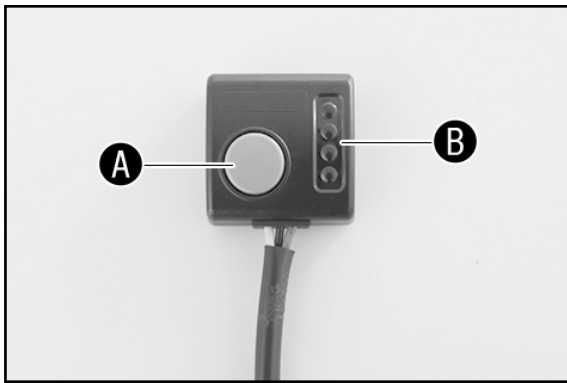

### Inserimento

- Tenere premuto il tasto **A** per ca. 3 secondi.

✓ Il LED **B** indica il rispettivo livello di riscaldamento.

Verde = livello 1  
Giallo = livello 2  
Arancione = livello 3  
Rosso = livello 4

### Disinserimento

- Tenere premuto il tasto **A** per ca. 3 secondi.

✓ Il LED **B** è spento.

### Modifica del livello di riscaldamento

- Premere il tasto **A** per passare tra i diversi livelli di riscaldamento.

#### AVVERTENZA

Quando viene eseguita la disattivazione, viene salvato il livello di riscaldamento selezionato in quel momento e tale livello viene richiamato al momento della riattivazione.

### Funzione di riscaldamento rapido

La funzione di riscaldamento rapido è sempre operativa per 4 minuti dopo l'attivazione. Durante il riscaldamento rapido lampeggia il LED del livello salvato.

La funzione di riscaldamento rapido può essere interrotta premendo il tasto **A**.

## 790 Adventure

### Montaggio manopole riscaldabili

- Disinserire il sistema d'accensione.
- Rimuovere le viti 11.
- Rimuovere entrambi gli spoiler della mascherina.

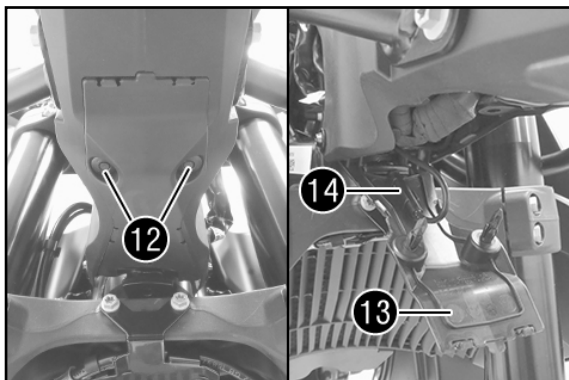
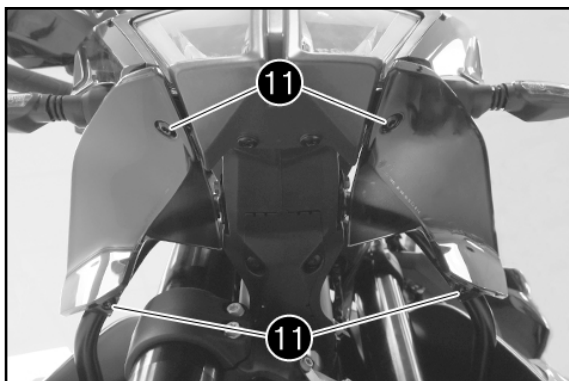

- Rimuovere i rivetti a espansione 12 e aprire la protezione 13.
- Sganciare il sensore temperatura 14.
- Rimuovere la protezione 13.

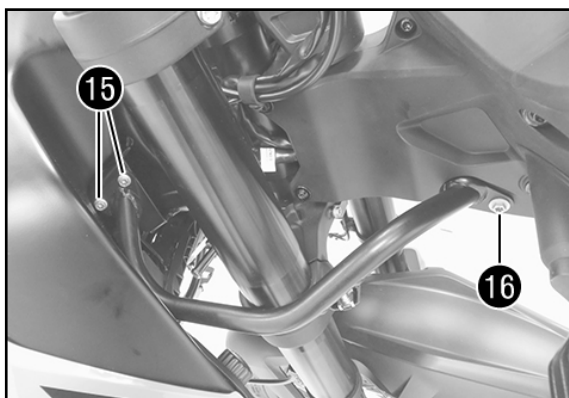

- Allentare le viti 15.
- Rimuovere le viti 16.

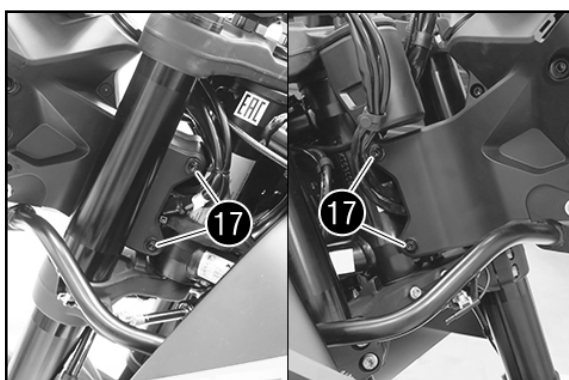

- Rimuovere le viti 17.
  - Tirare il faro in avanti.
- AVVISO  
Coprire i componenti per evitare di danneggiarli.

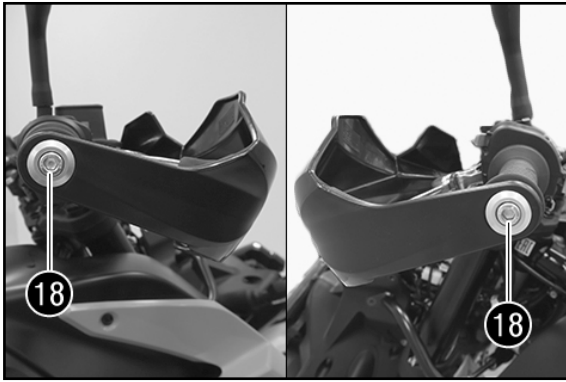

- Allentare le viti 18.

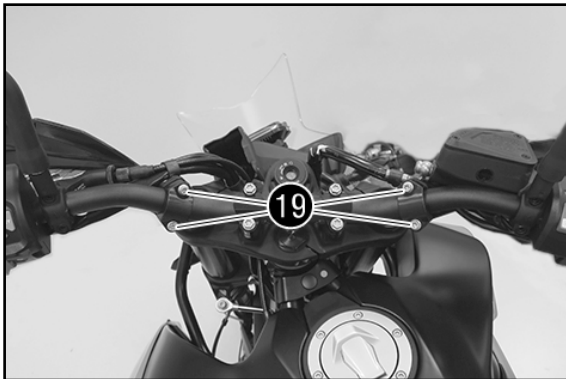

- Rimuovere i raccordi a vite 19.  
- Rimuovere i paramani e i contrappesi del manubrio.

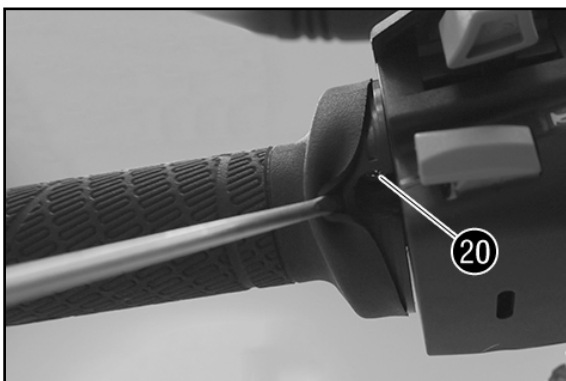

#### Parte sinistra

- Sollevare leggermente la manopola in gomma.  
- Allentare la vite 20.  
- Rimuovere la manopola fissa.

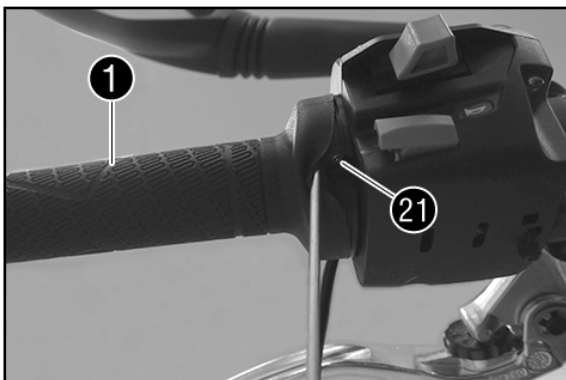

- Posizionare la manopola riscaldabile sinistra 1 (in dotazione) sul manubrio.  
- Sollevare leggermente la manopola in gomma.  
- Serrare la vite premontata 21.



#### Parte destra

- Rimuovere le viti 22.  
- Rimuovere la protezione.  
- Staccare la manopola dell'acceleratore dal manubrio.

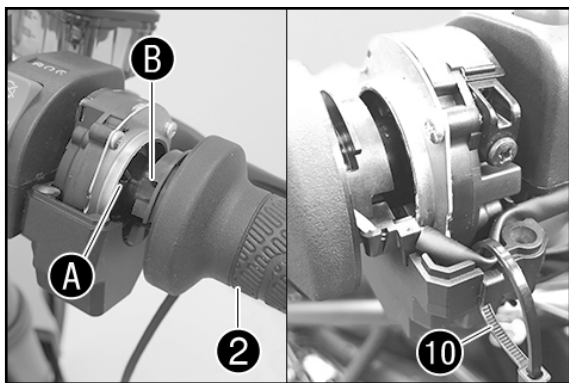

- Posizionare la manopola riscaldabile destra ② (in dotazione) sul manubrio.

✓ Il nasello ① si innesta nel mozzetto della frizione ②.

- Posizionare il cavo nel sensore manopola dell'acceleratore in modo che non sia in tensione (nel modo illustrato in figura) e assicurarne con una fascetta ⑩ (in dotazione).

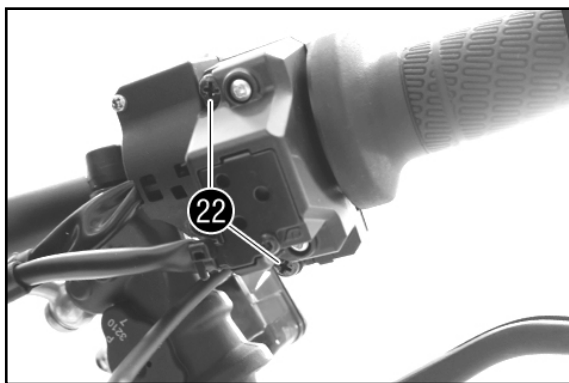

- Posizionare la protezione.

### ! AVVERTIMENTO

**Assicurarsi che il cavo non rischi di venire piegato o bloccato in qualche modo!**

- Montare le viti originali ②② e serrarle a 3,5 Nm.



### Posa dei cavi

- Posare i cavi delle manopole riscaldabili su entrambi i lati lungo i cavi presenti, verso la mascherina portafaro.

- Collegare il connettore ②③ delle due manopole riscaldabili.

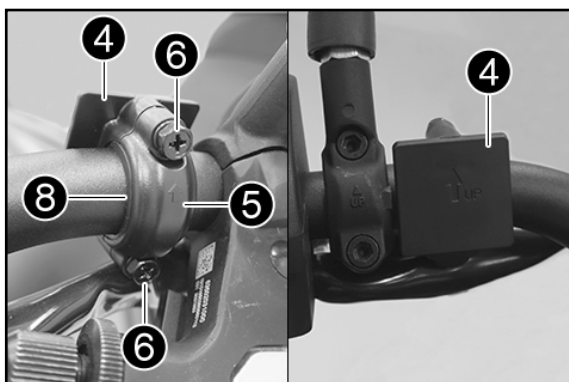

### Montaggio centralina elettronica

- Posizionare il supporto superiore ④ e inferiore ⑤ con la protezione in gomma ③ (tutto in dotazione) sulla parte del manubrio desiderata.

- Montare le viti ⑥ con gli anelli (elastici) di sicurezza ⑦ (tutto in dotazione) e serrare a 2 Nm.

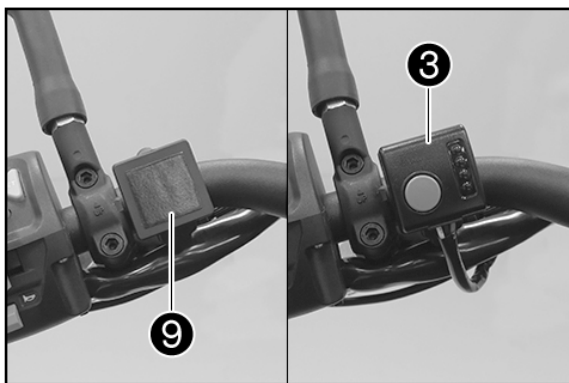

- Incollare il nastro biadesivo ⑨ (in dotazione) sul supporto.

- Incollare la centralina elettronica ③ ed eventualmente assicurarla con fascette ⑩ (in dotazione).



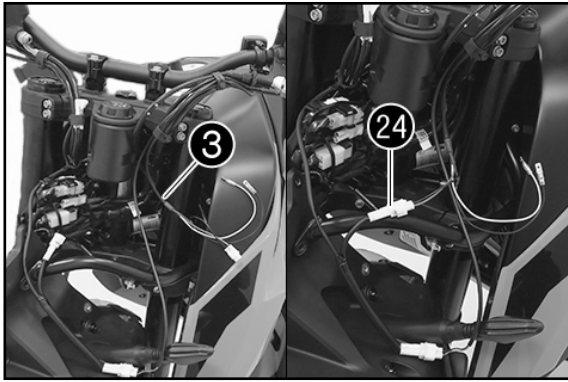

- Posare il cablaggio della centralina elettronica ③ lungo i cavi presenti, verso la mascherina portafaro.

- Collegare il connettore ②④.



- Sfilare il cablaggio ACC2 ②⑤ dalla mascherina portafaro.

- Collegare il cablaggio della centralina elettronica ad ACC2 in base ai colori.

#### AVVISO

Sui cavi è presente un adesivo con le scritte ACC1 e ACC2.

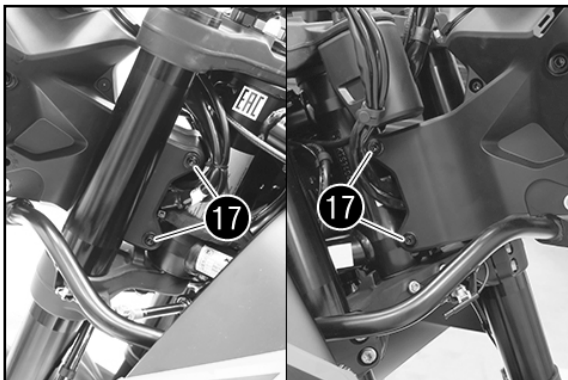

#### Riassemblaggio

- Posizionare la mascherina portafaro.

#### AVVISO

Posare correttamente i cavi, assicurandosi che non vengano piegati o pizzicati.

- Montare le viti ①⑦ e serrarle a 10 Nm (Loctite 243).

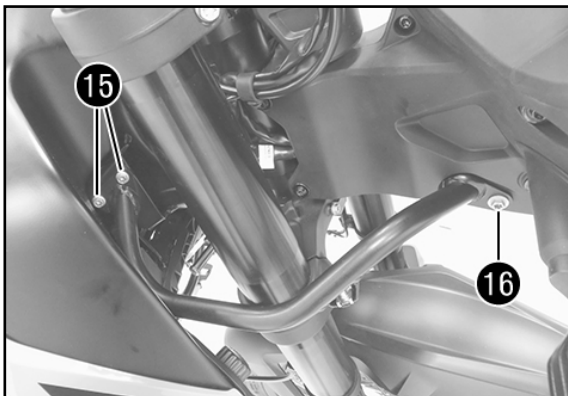

- Montare le viti ①⑥ e serrarle a 10 Nm (Loctite 243).

- Serrare le viti ①⑥ a 10 Nm.



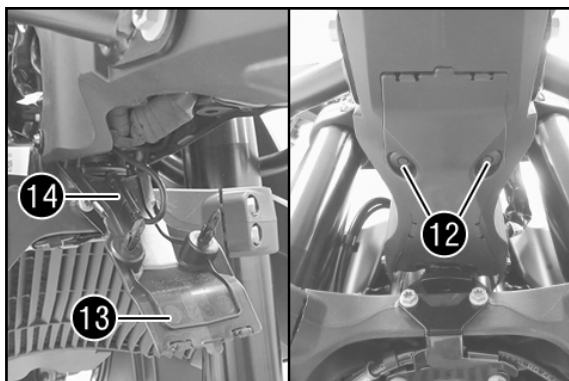

- Posizionare la protezione 13.
- Agganciare il sensore temperatura 14.
- Montare la protezione con rivetti a espansione 12.

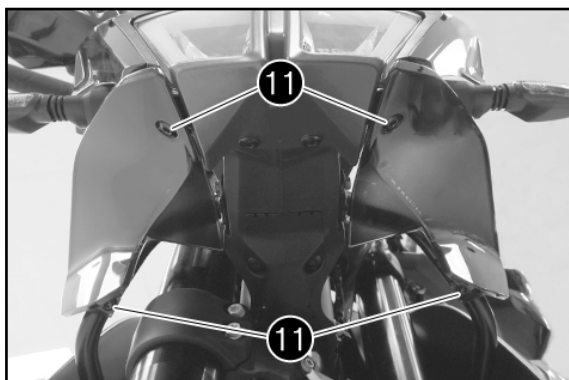

- Posizionare gli spoiler della mascherina.
- Montare le viti 11 e serrarle a 3 Nm.

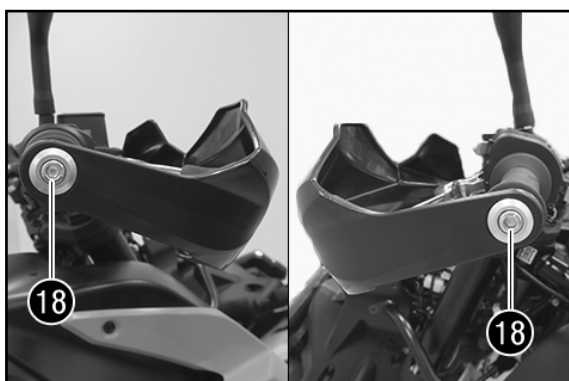

- Posizionare i paramani con i contrappesi del manubrio.
- Serrare la vite 18 a 25 Nm.

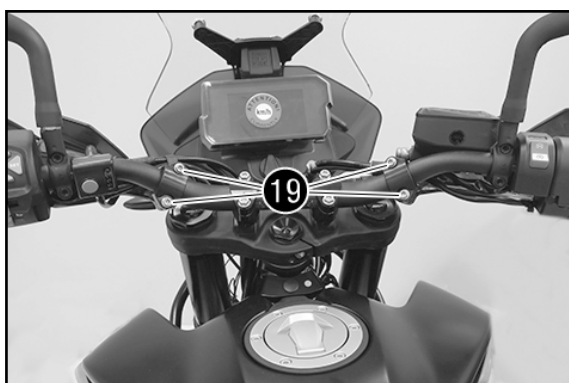

- Posizionare i paramani sul manubrio.
- Montare i raccordi a vite 19 e serrarli a 6 Nm.

#### Operazione conclusiva

- Controllare l'orientamento del faro (v. manuale d'uso).

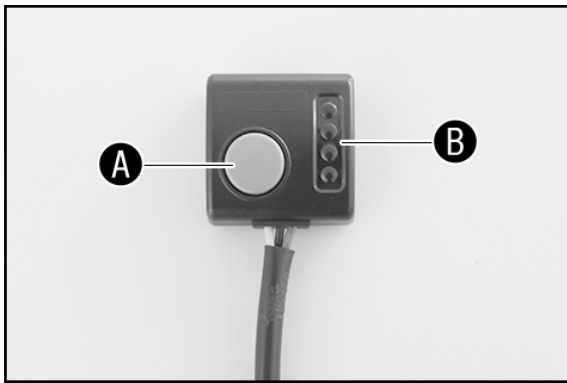

### Accensione

- Tenere premuto il tasto **A** per ca. 3 secondi.

✓ Il LED **B** indica il rispettivo livello di riscaldamento.

Verde = livello 1  
Giallo = livello 2  
Arancione = livello 3  
Rosso = livello 4

### Spegnimento

- Tenere premuto il tasto **A** per ca. 3 secondi.

✓ Il LED **B** è spento.

### Modifica del livello di riscaldamento

- Premere il tasto **A** per passare tra i diversi livelli di riscaldamento.

#### AVVISO

Quando si spengono le manopole, viene salvato il livello di riscaldamento selezionato in quel momento e tale livello viene richiamato al momento della riaccensione.

### Funzione di riscaldamento rapido

La funzione di riscaldamento rapido è sempre operativa per 4 minuti dopo l'accensione. Durante il riscaldamento rapido lampeggia il LED del livello salvato.

La funzione di riscaldamento rapido può essere interrotta premendo il tasto **A**.

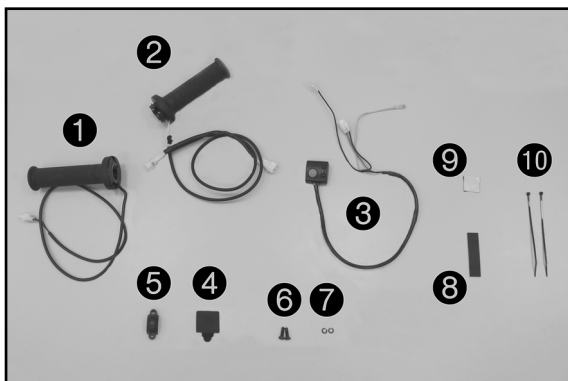

## Contenu de la livraison

- 1x poignée chauffante gauche ❶
- 1x poignée chauffante droite ❷
- 1x unité de contrôle de la poignée chauffante ❸
- 1x fixation supérieure ❹
- 1x fixation inférieure ❺
- 2x vis M5x15 ❻
- 2x clips ❼
- 1x protection en caoutchouc ❽
- 1x bande adhésive double-face ❾
- 2x rilsans ❿

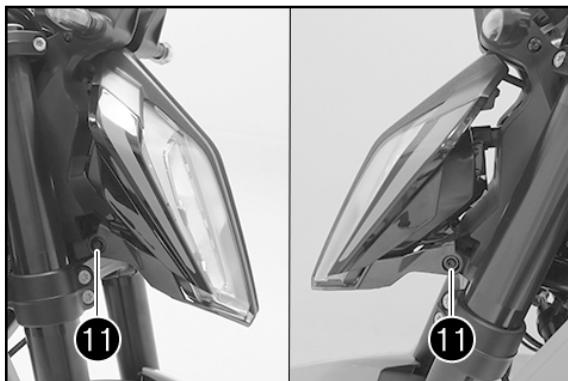

## 790 Duke

### Montage des poignées chauffantes

- Couper le contact.
- Retirer les vis ❶.

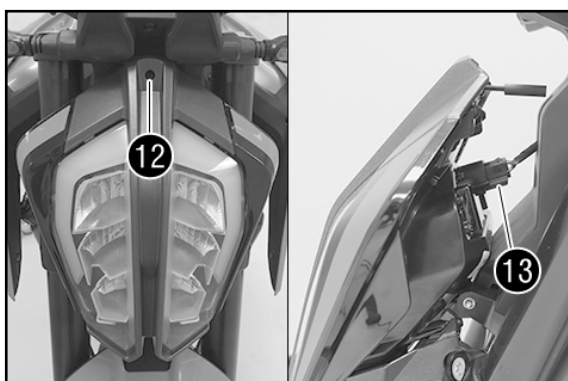

- Dévisser complètement la vis de réglage ❷.

#### REMARQUE

La vis de réglage est maintenue sur la plaque-phare par une fixation à tête de rotule.  
Ne pas retirer la vis de réglage de la fixation à tête de rotule.

- Basculer la plaque-phare légèrement vers l'avant et débrancher le connecteur ❸.
- Déposer le phare.

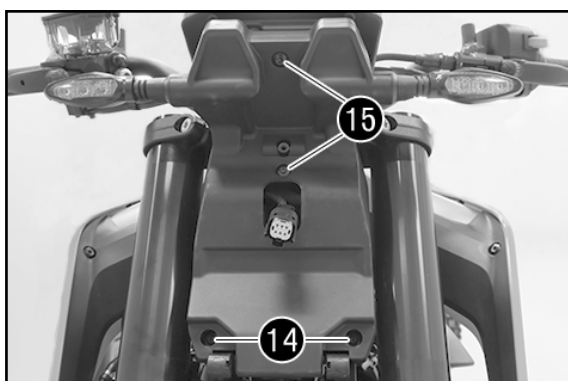

- Retirer les vis ❶.
- Retirer les vis ❷.
- Retirer les vis ❸.

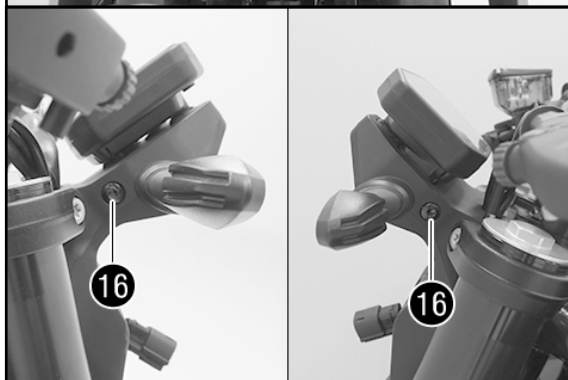



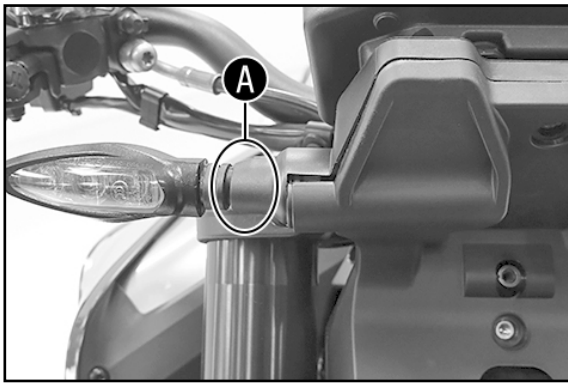

- Saisir le clignotant dans la zone **A** et appuyer avec précaution dans la direction opposée au sens de marche.

✓ Le cache se détache comme indiqué sur la figure.

- Répéter l'étape de travail du côté opposé.  
- Déposer le cache.

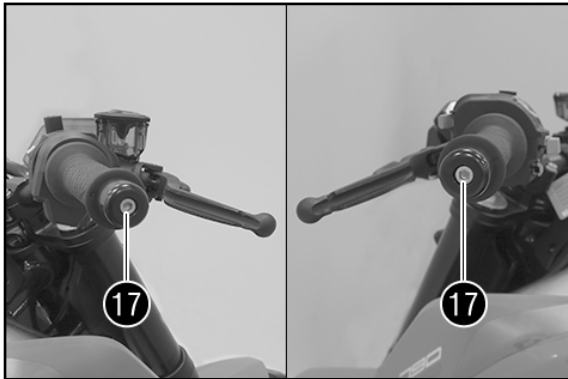

- Desserrer les vis **17** et retirer les embouts de guidon.

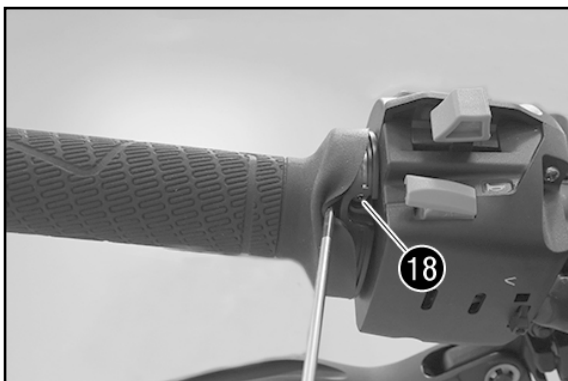

#### Côté gauche

- Soulever légèrement la poignée caoutchouc.  
- Desserrer la vis **18**.  
- Enlever la poignée fixe.

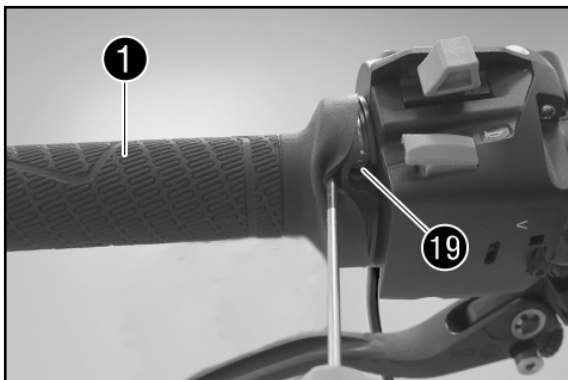

- Positionner la poignée chauffante gauche **1** (fournie à la livraison) sur le guidon.  
- Soulever légèrement la poignée caoutchouc.  
- Serrer la vis **19**.



#### Côté droit

- Retirer les vis **20**.  
- Déposer le cache.  
- Dégager la poignée des gaz du guidon.

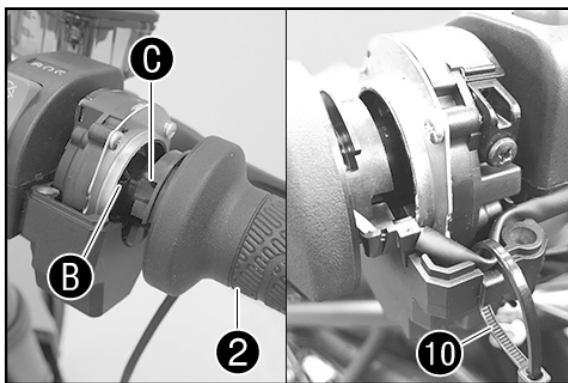

- Positionner la poignée chauffante droite ② (fournie à la livraison) sur le guidon.

✓ L'ergot ③ s'engage dans la noix d'embrayage ④.

- Poser le câble du capteur de poignée d'accélération de manière à ce qu'il ne soit soumis à aucune contrainte (voir illustration) et le fixer à l'aide d'un rilsan ⑩ (fournie à la livraison).

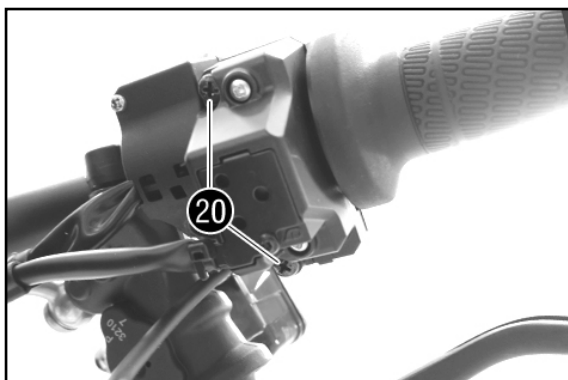

- Positionner le cache.

### ! ATTENTION

Veiller à ce que le câble ne soit ni plié ni coincé !

- Mettre les vis d'origine ⑳ en place et les serrer à 3,5 Nm.

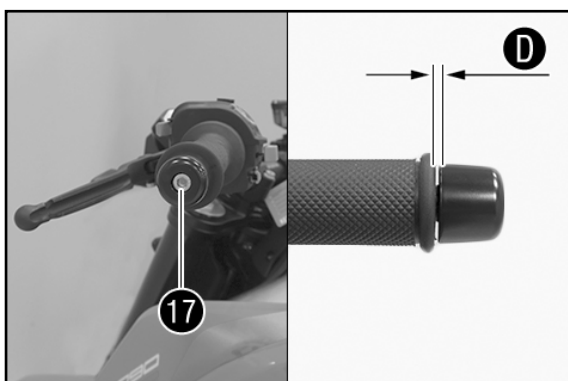

- Mettre l'embout de guidon gauche en place et serrer la vis ⑰ à 10 Nm.

- Mettre l'embout de guidon droit en place en laissant un écart ① de 2 mm et serrer la vis ⑰ à 10 Nm.

### REMARQUE

Respecter l'écart afin d'éviter que la poignée des gaz ne se bloque.

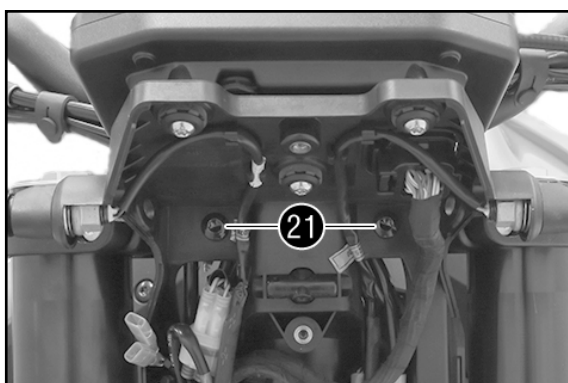

### Emplacement des câbles

- Retirer les vis ⑳.

- Tirer le cache légèrement vers l'avant.

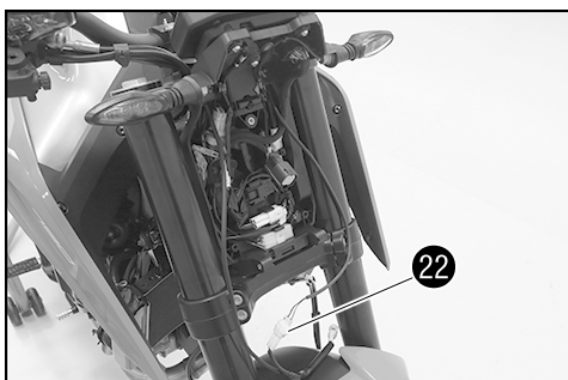

- Placer les câbles des poignées chauffantes des deux côtés le long des câbles déjà en place, en direction de la plaque-phare.

- Brancher le connecteur ⑳ des deux poignées chauffantes.

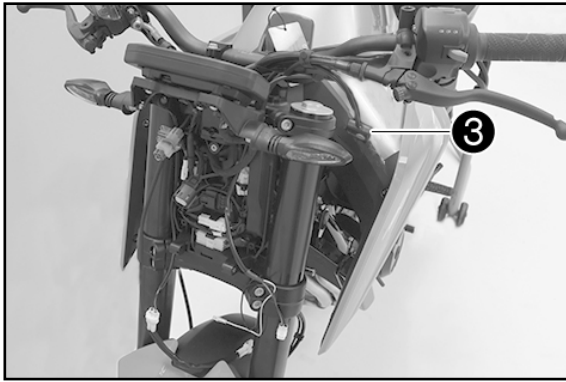

## Montage de l'unité de contrôle

- Placer le faisceau de câbles de l'unité de contrôle **3** (fournie à la livraison), en fonction de la partie du guidon souhaitée, le long des câbles déjà en place, en direction de la plaque-phare.

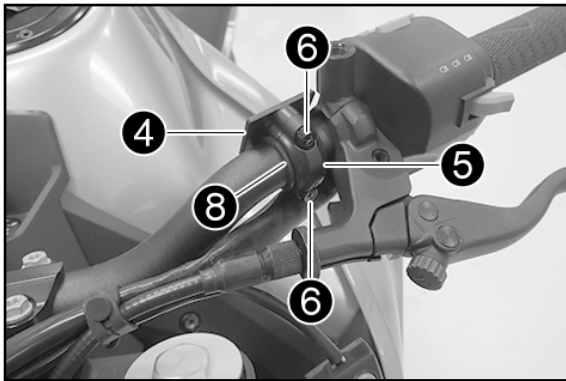

- Mettre en place la fixation supérieure **4** et la fixation inférieure **5** avec la protection en caoutchouc **8** (tous fournis à la livraison).  
- Mettre en place les vis **6** avec les clips **7** (tous fournis à la livraison) et les serrer à 2 Nm.

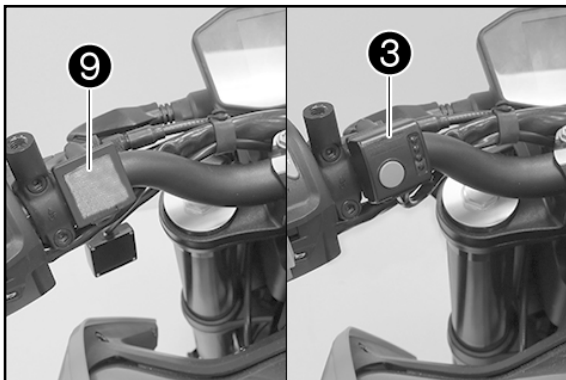

- Appliquer la bande adhésive double-face **9** (fournie à la livraison) sur la fixation supérieure **4**.

- Coller l'unité de contrôle **3** et, si nécessaire, la fixer à l'aide de rilsans **10** (fournis à la livraison).

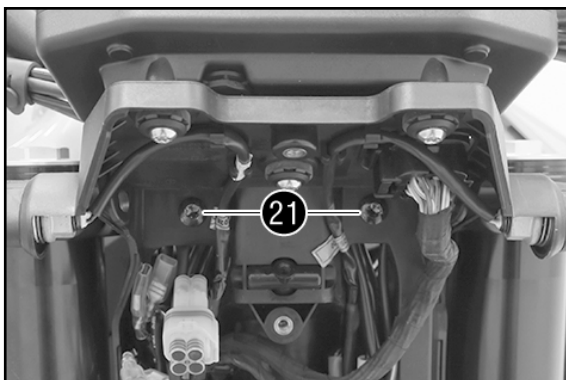

- Mettre en place le cache et les vis **21** et serrer à 5 Nm.

### ! ATTENTION

**Veiller à ce que le câble ne soit ni plié ni coincé !**

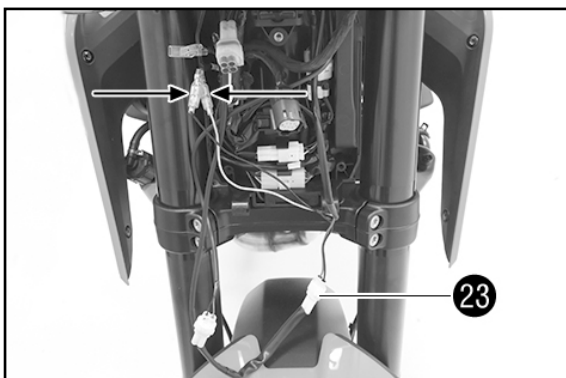

- Brancher le connecteur **23**.  
- Connecter le faisceau de câbles de l'unité de contrôle à l'ACC2 du faisceau de câbles du véhicule.

### REMARQUE

- Les câbles sont dotés d'un autocollant portant l'inscription ACC2.

- Poser le câble de manière à ce qu'il ne soit soumis à aucune contrainte et, si nécessaire, le fixer à l'aide de rilsans.

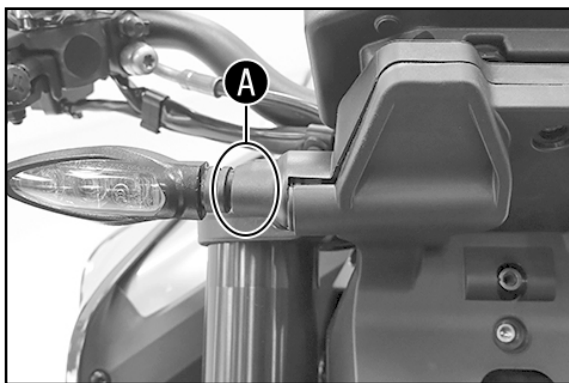

### Assemblage

- Positionner le cache en faisant passer le connecteur du phare par l'ouverture.
- Saisir le clignotant dans la zone **A** et appuyer avec précaution dans la direction opposée au sens de marche tout en appuyant fermement sur le cache.

✓ L'emboîtement du cache est perceptible à l'oreille.

- Répéter l'étape de travail du côté opposé.

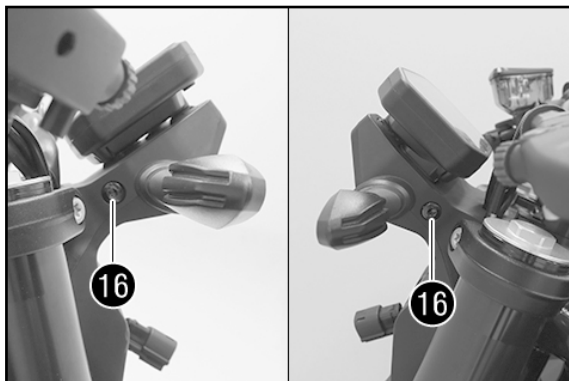

- Mettre en place les vis **16** et les serrer à 5 Nm.
- Mettre en place les vis **15** et les serrer à 5 Nm.
- Mettre en place les vis **14** et les serrer à 2 Nm.

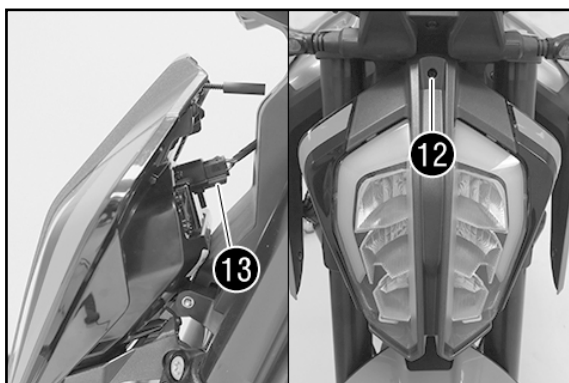
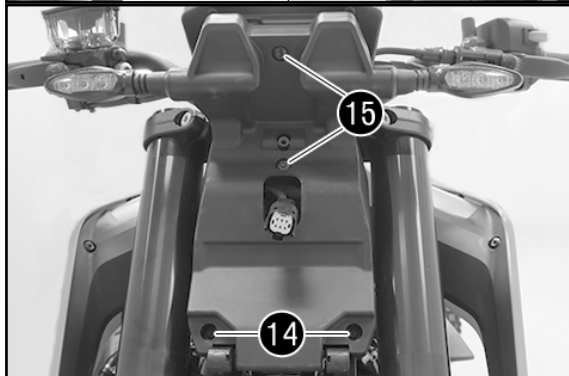

- Brancher le connecteur **13**.
- Positionner la plaque-phare.
- Mettre en place la vis de réglage **12**.

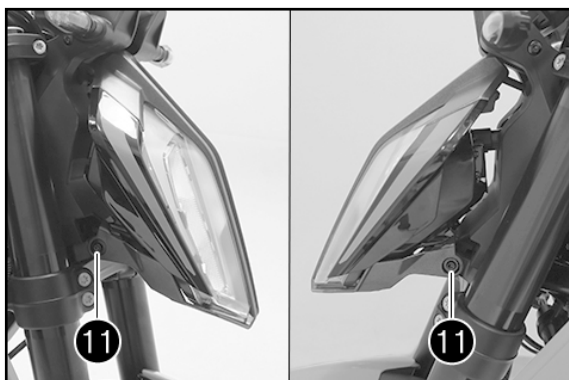

- Mettre en place les vis **11** et les serrer à 2 Nm.

### Travaux ultérieurs

- Contrôler le réglage du phare (voir le manuel d'utilisation).
- Régler la portée du phare (cf. manuel d'utilisation).



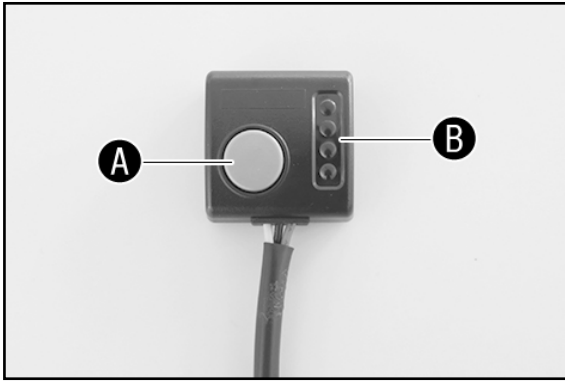

### Allumage

- Maintenir la touche **A** enfoncée pendant environ 3 secondes.
- ✓ Les voyants LED **B** affichent le niveau de chauffage correspondant.

Vert = niveau 1  
Jaune = niveau 2  
Orange = niveau 3  
Rouge = niveau 4

### Arrêt

- Maintenir la touche **A** enfoncée pendant environ 3 secondes.
- ✓ Les voyants LED **B** s'éteignent.

### Changer le niveau de chauffage

- Enfoncer la touche **A** afin de naviguer entre les différents niveaux de chauffage.

#### REMARQUE

Lors de l'arrêt, le niveau de chauffage sélectionné est enregistré et maintenu à l'allumage suivant.

### Fonction de chauffage rapide

La fonction de chauffage rapide fonctionne toujours pendant 4 minutes à partir de l'allumage. Lors du chauffage rapide, le voyant LED correspondant au niveau enregistré clignote. La fonction de chauffage rapide peut être interrompue en enfonçant la touche **A**.

## 790 Adventure

### Montage des poignées chauffantes

- Couper le contact.
- Retirer les vis 11.
- Retirer les deux déflecteurs de plaque-phare.

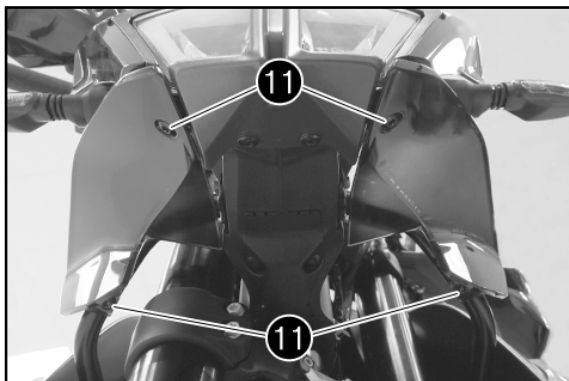

- Retirer les rivets à expansion 12 et ouvrir le cache 13.
- Décrocher le capteur de température 14.
- Retirer le cache 13.

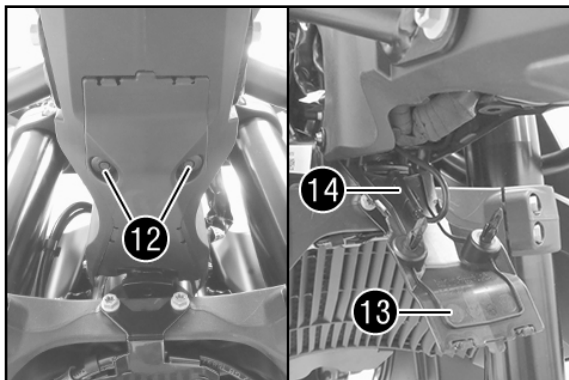

- Desserrer les vis 15.
- Retirer les vis 16.



- Retirer les vis 17.
  - Tirer le phare vers l'avant.
- REMARQUE  
Protéger les composants de tout dommage en les recouvrant.

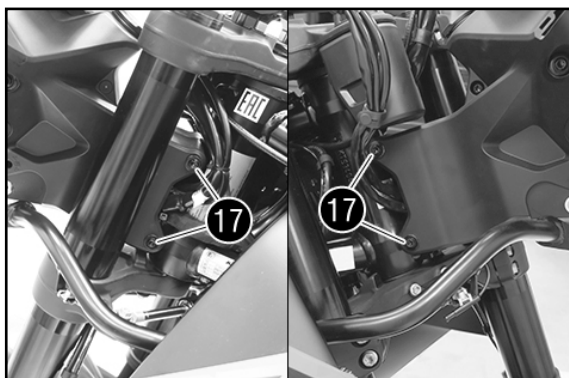

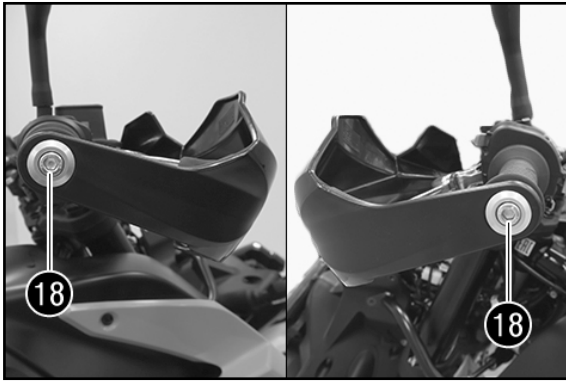

- Desserrer les vis 18.

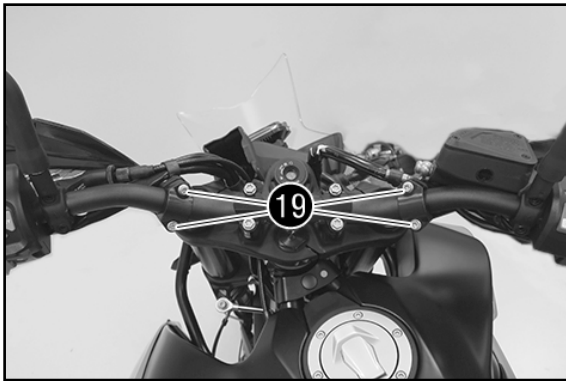

- Retirer les assemblages vissés 19.  
- Retirer les protège-main et les embouts de guidon.

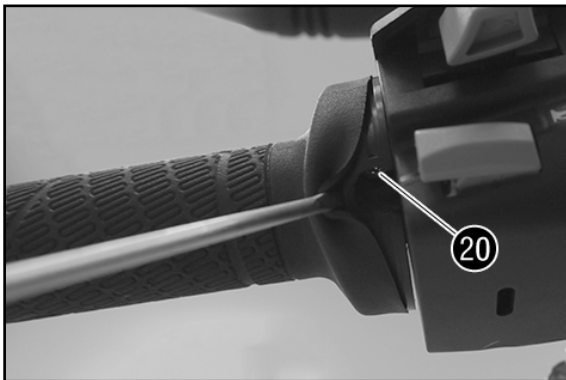

#### Côté gauche

- Soulever légèrement la poignée caoutchouc.  
- Desserrer la vis 20.  
- Enlever la poignée fixe.

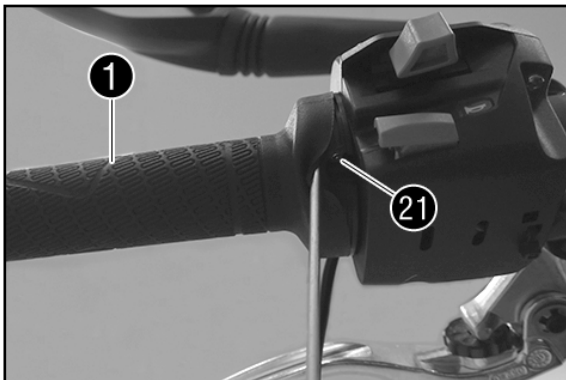

- Positionner la poignée chauffante gauche 1 (fournie) sur le guidon.  
- Soulever légèrement la poignée caoutchouc.  
- Serrer la vis prémontée 21.



#### Côté droit

- Enlever les vis 22.  
- Déposer le cache.  
- Dégager la poignée de gaz du guidon.

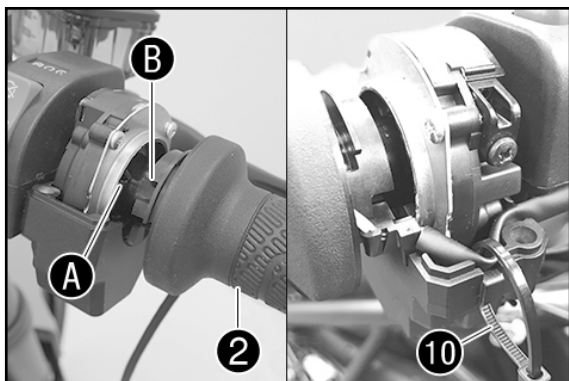

- Positionner la poignée chauffante droite ② (fournie à la livraison) sur le guidon.

✓ L'ergot A s'engage dans la noix d'embrayage B.

- Poser le câble du capteur de poignée de gaz de manière à ce qu'il ne soit soumis à aucune contrainte (voir illustration) et le fixer à l'aide d'un rilsan ⑩ (compris dans la livraison).

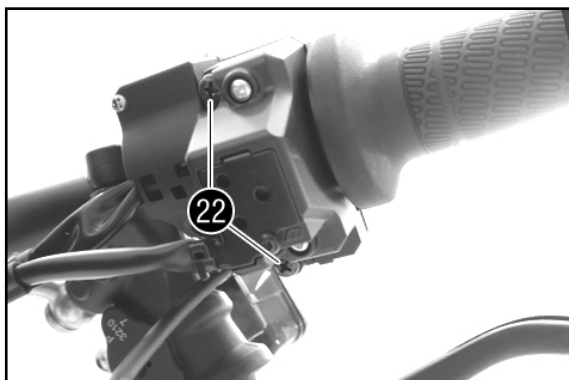

- Positionner le cache.

### ! ATTENTION

Veiller à ce que le câble ne soit ni plié ni coincé !

- Mettre les vis d'origine ②② en place et les serrer à 3,5 Nm.

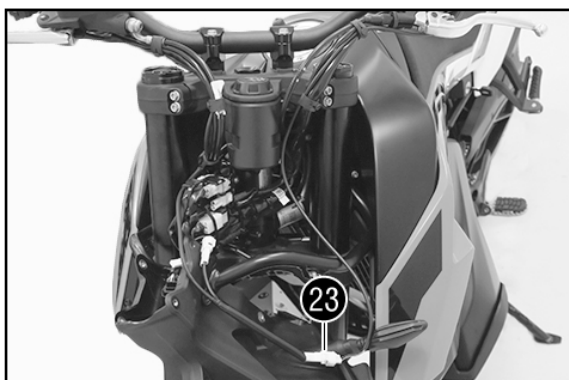

### Agencement des câbles

- Placer les câbles des poignées chauffantes des deux côtés le long des câbles déjà en place, en direction de la plaque-phare.

- Brancher le connecteur ②③ des deux poignées chauffantes.

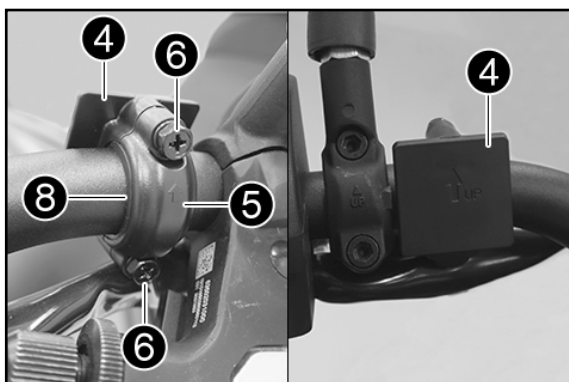

### Montage de l'unité de contrôle

- Mettre en place les fixations supérieure ④ et inférieure ⑤ avec la protection en caoutchouc ③ (toutes fournies à la livraison) sur la partie du guidon souhaitée.

- Mettre en place les vis ⑥ avec les clips ⑦ (tous fournis à la livraison) et les serrer à 2 Nm.

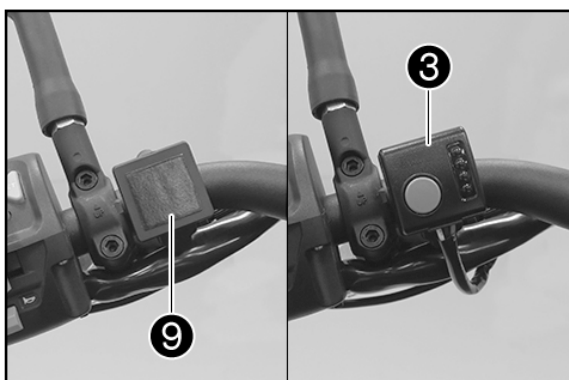

- Coller la bande adhésive double face ⑨ (comprise dans la livraison) sur la fixation.

- Coller l'unité de contrôle ③ et, si nécessaire, la fixer à l'aide de rilsans ⑩ (fournis à la livraison).



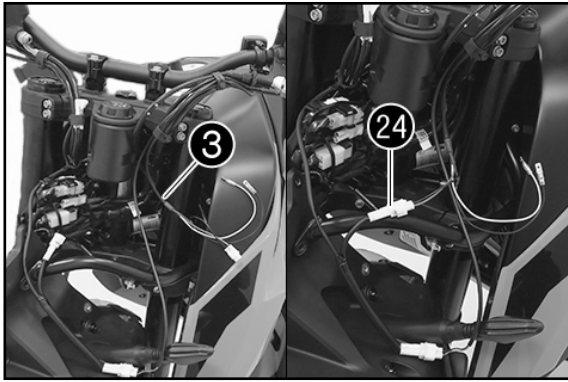

- Placer le faisceau de câbles de l'unité de contrôle **3** le long des câbles déjà en place en direction de la plaque-phare.

- Brancher le connecteur **24**.



- Dégager le faisceau de câbles ACC2 **25** de la plaque-phare.

- Brancher le faisceau de câbles de l'unité de contrôle sur l'ACC2 en respectant les couleurs.

#### REMARQUE

Sur les câbles se trouve un autocollant portant les inscriptions ACC1 et ACC2.

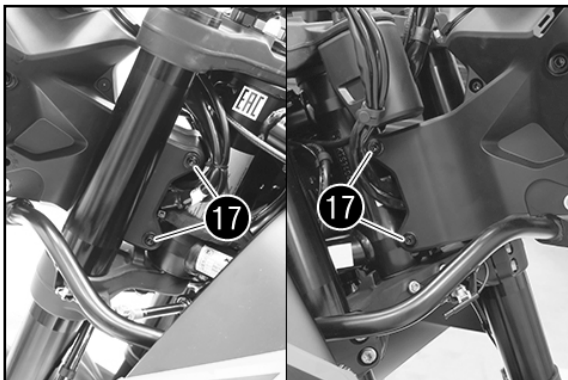

#### Assemblage

- Positionner la plaque-phare.

#### REMARQUE

Poser les câbles correctement et s'assurer qu'ils ne sont ni pliés ni coincés.

- Mettre en place les vis **17** et les serrer à 10 Nm (Loctite 243).

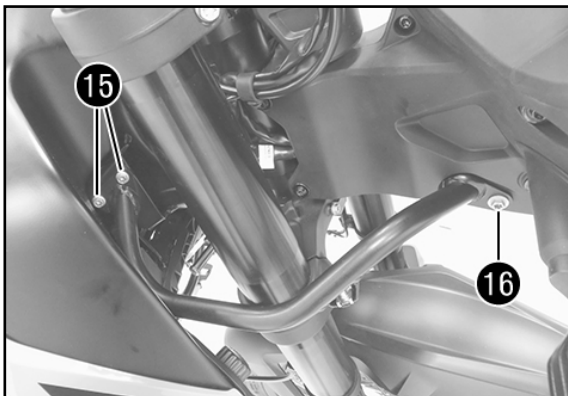

- Mettre en place les vis **16** et les serrer à 10 Nm (Loctite 243).

- Serrer les vis **15** à 10 Nm.



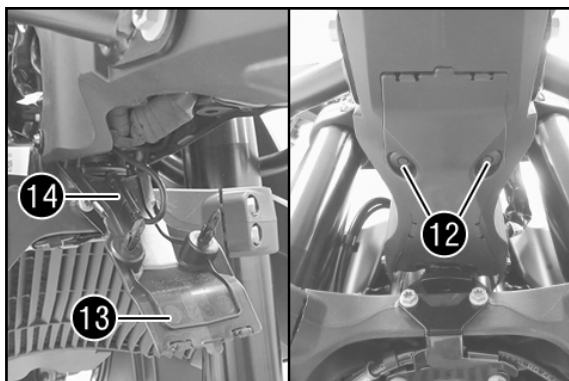

- Mettre le cache 13 en place.
- Accrocher le capteur de température 14.
- Monter le cache avec les rivets à expansion 12.

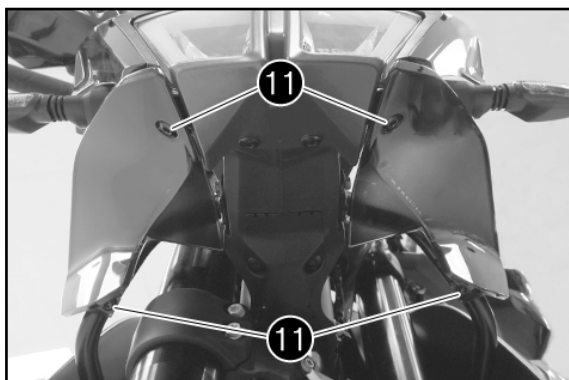

- Mettre en place les déflecteurs de plaque-phare.
- Mettre en place les vis 11 et les serrer à 3 Nm.

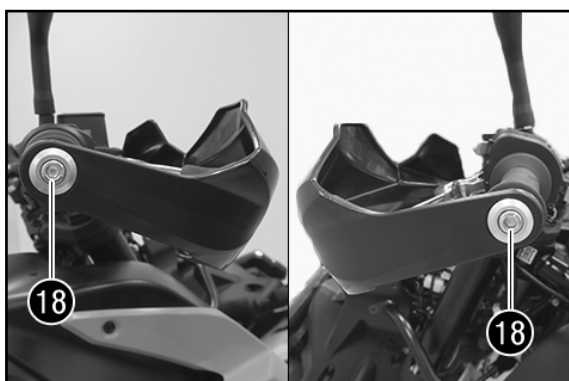

- Mettre en place le protège-main avec l'embout de guidon.
- Serrer la vis 18 à 25 Nm.

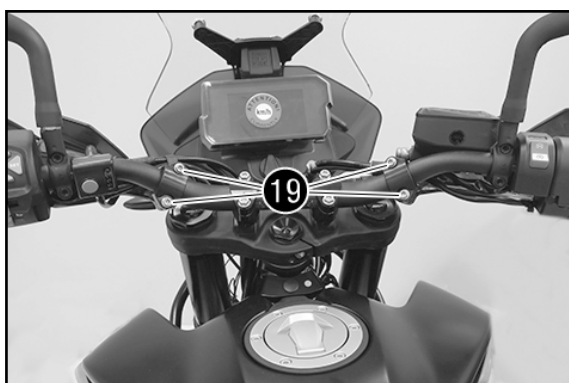

- Mettre en place le protège-main sur le guidon.
- Mettre en place les assemblages vissés 19 et les serrer à 6 Nm.

#### Travaux ultérieurs

- Contrôler le réglage du phare (voir le manuel d'utilisation).

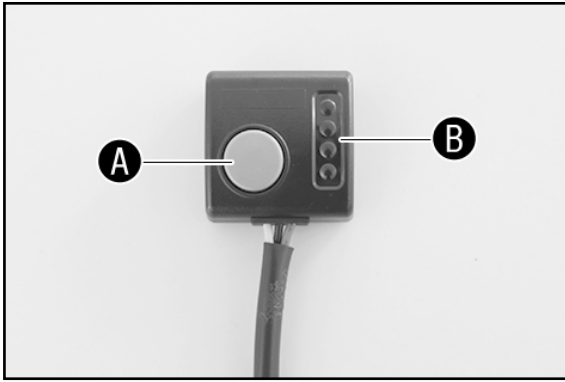

### Allumage

- Maintenir la touche **A** enfoncée pendant environ 3 secondes.
- ✓ Les voyants LED **B** affichent le niveau de chauffage correspondant.

Vert = niveau 1  
Jaune = niveau 2  
Orange = niveau 3  
Rouge = niveau 4

### Arrêt

- Maintenir la touche **A** enfoncée pendant environ 3 secondes.
- ✓ Les voyants LED **B** s'éteignent.

### Changer le niveau de chauffage

- Appuyer sur la touche **A** afin de naviguer entre les différents niveaux de chauffage.

### REMARQUE

Lors de l'arrêt, le niveau de chauffage sélectionné est enregistré et maintenu lors de l'allumage suivant.

### Fonction de chauffage rapide

La fonction de chauffage rapide fonctionne toujours pendant 4 minutes à partir de l'allumage. Lors du chauffage rapide, le voyant LED correspondant au niveau enregistré clignote. La fonction de chauffage rapide peut être interrompue en enfonçant la touche **A**.

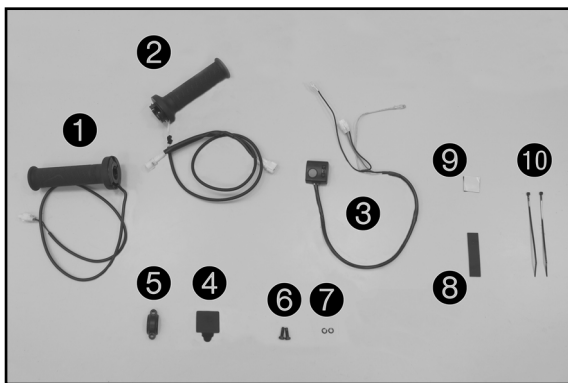

### Volumen de suministro

- 1x puño calefactable izquierdo ❶
- 1x puño calefactable derecho ❷
- 1x unidad de control de puño calefactable ❸
- 1x fijación superior ❹
- 1x fijación inferior ❺
- 2x tornillos M5x15 ❻
- 2x anillos de sujeción ❼
- 1x protección de goma ❸
- 1x cinta adhesiva de doble cara ❾
- 2x bridas ❿

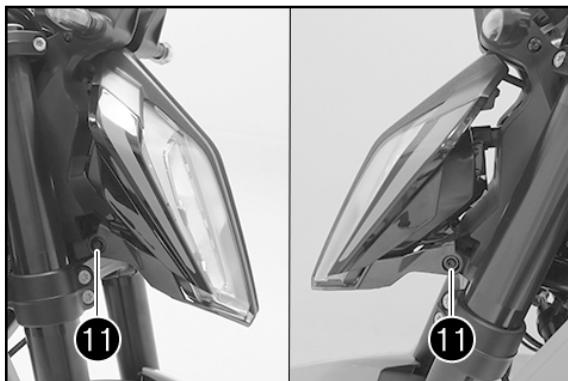

### 790 Duke

#### Montaje de los puños calefactables

- Desconectar el sistema de encendido.
- Retirar los tornillos ❾.

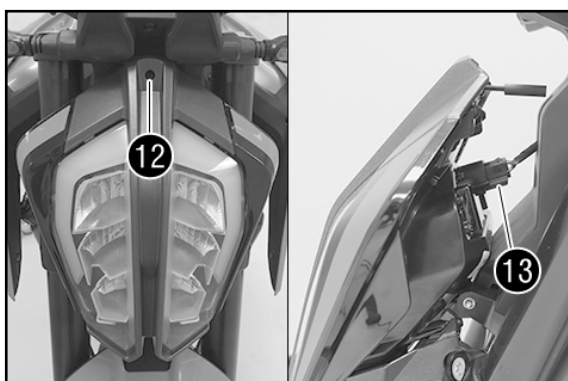

- Extraer completamente el mando de ajuste ❿.

#### AVISO

El mando de ajuste está sujeto mediante un soporte de rótula a la máscara de faro.  
No sacar el mando de ajuste del soporte de rótula.

- Abatir la máscara de faro ligeramente hacia delante y desconectar la clema ❿.
- Quitar el faro.

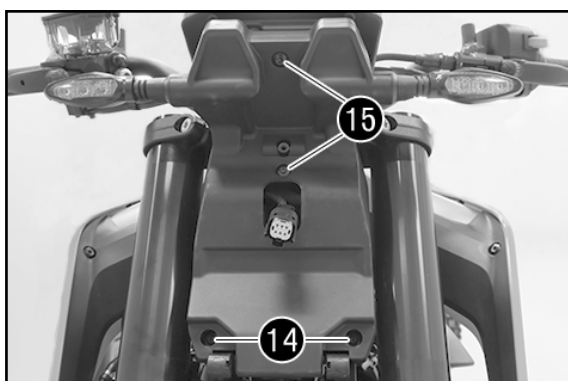

- Retirar los tornillos ❿.
- Retirar los tornillos ❿.
- Retirar los tornillos ❿.

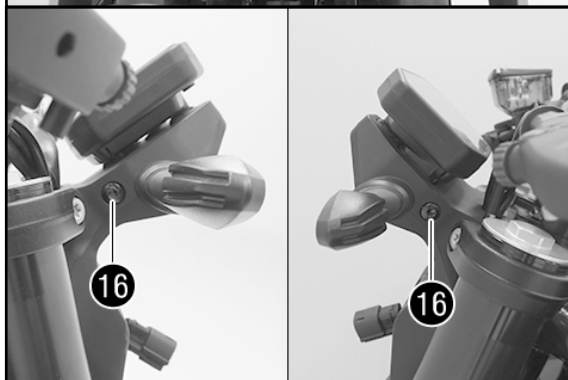



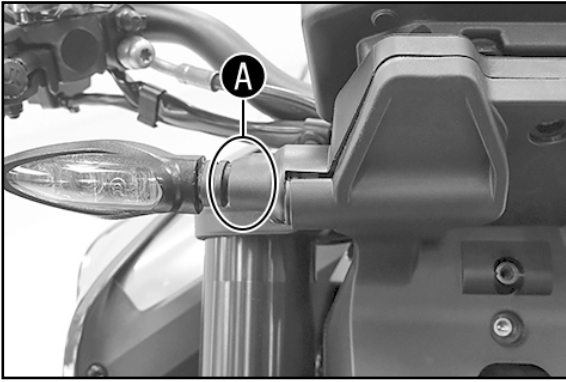

- Sujetar el intermitente en la zona **A** y empujarlo con cuidado en contra de la dirección de marcha.

✓ La tapa se suelta como se muestra en la imagen.

- Repetir el paso de trabajo en el lado opuesto.
- Retirar la tapa.

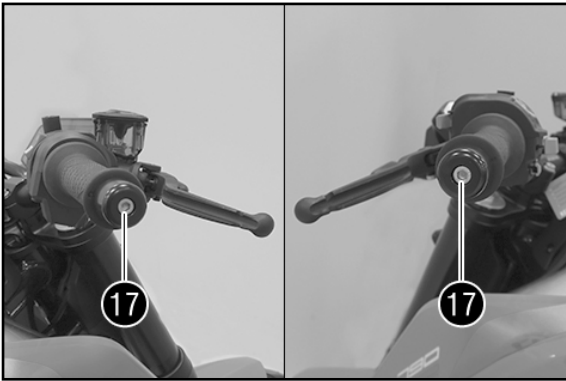

- Soltar los tornillos **17** y retirar el contrapeso del manillar.

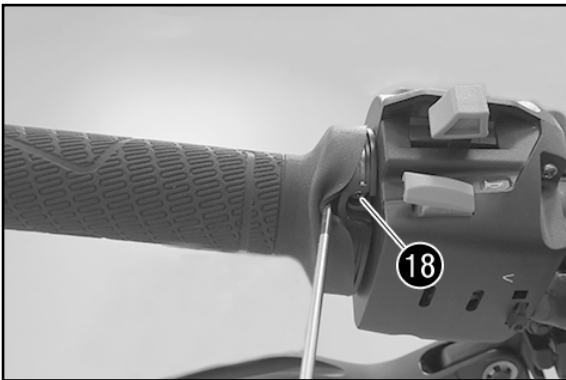

#### Lado izquierdo

- Levantar ligeramente el puño de goma.
- Soltar el tornillo **18**.
- Retirar el puño fijo.

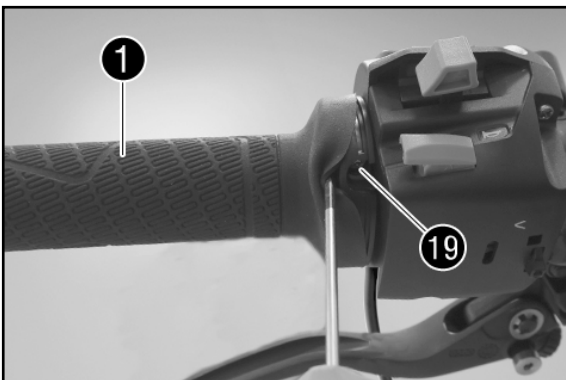

- Colocar el puño calefactable izquierdo **1** (volumen de suministro) en el manillar.
- Levantar ligeramente el puño de goma.
- Apretar el tornillo **19**.



#### Lado derecho

- Retirar los tornillos **20**.
- Quitar la tapa.
- Extraer el puño de gas del manillar.

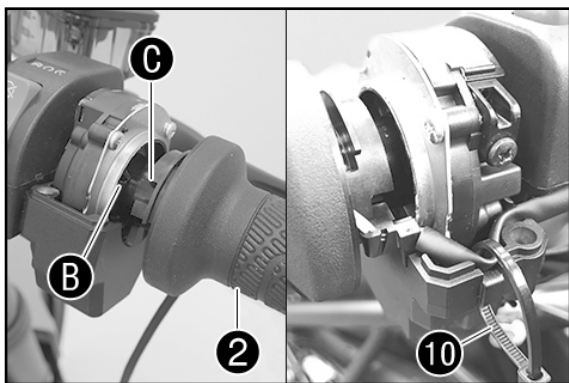

- Colocar el puño calefactable derecho ② (volumen de suministro) en el manillar.

✓ El talón ③ engrana en el tambor interior de embrague ④.

- Tender el cable en el sensor del puño del acelerador sin tensiones (como se muestra en la figura) y asegurarlo con bridas ⑩ (volumen de suministro).

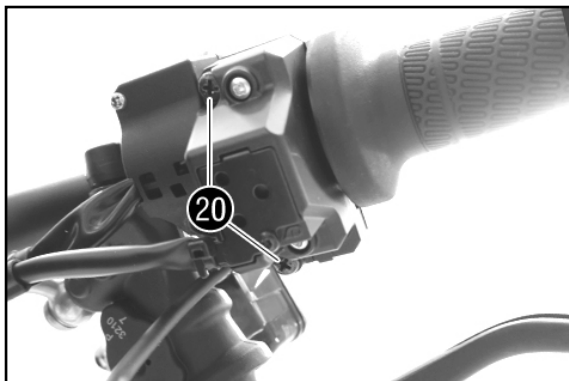

- Colocar la tapa.

### ! AVISO

¡Asegurarse de que el cable no pueda retorcerse ni quedar aprisionado!

- Montar los tornillos originales ⑳ y apretarlos a 3,5 Nm.

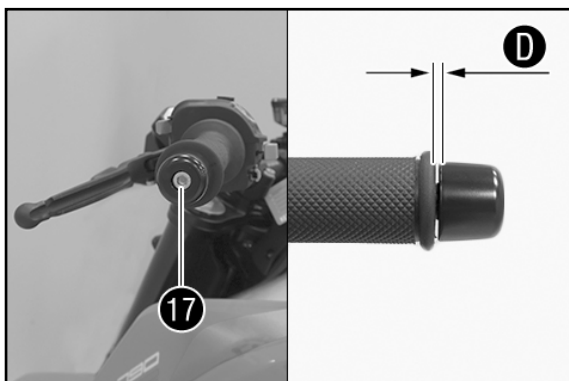

- Montar el contrapeso izquierdo del manillar y apretar el tornillo ⑰ a 10 Nm.

- Colocar el contrapeso derecho del manillar a la distancia ① (2 mm) y apretar el tornillo ⑰ a 10 Nm.

### AVISO

Tener en cuenta la distancia para evitar que se atasque el puño de gas.

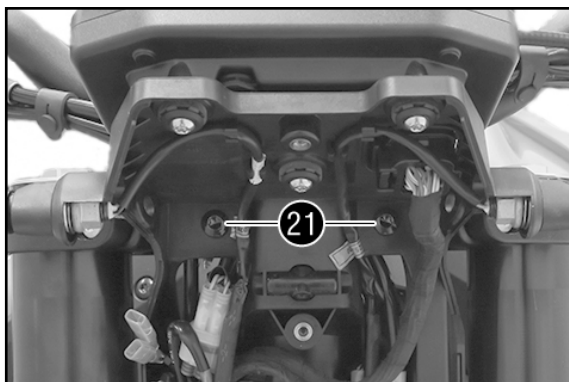

### Tendido de los cables

- Retirar los tornillos ⑳.

- Tirar ligeramente de la tapa hacia delante.

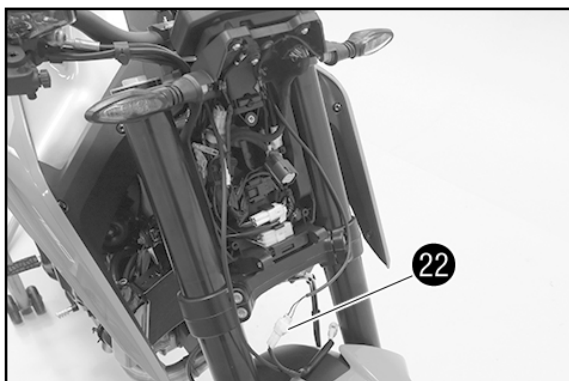

- Tender el cable del puño calefactable hacia la máscara de faro junto a los demás cables.

- Enchufar el conector ⑳ de ambos puños calefactables.

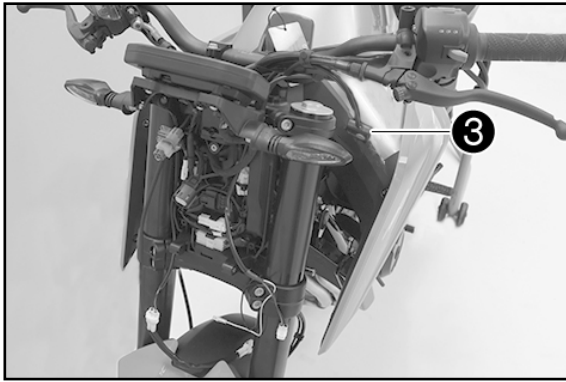

## Montaje de la unidad de control

- Tender el cableado de la unidad de control ③ (volumen de suministro), desde la mitad del manillar deseada, hacia la máscara de faro junto a los demás cables.

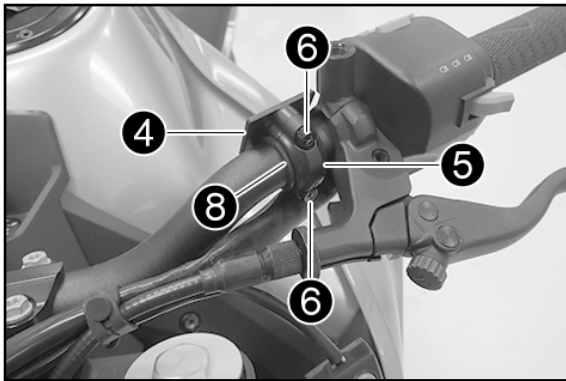

- Colocar la fijación superior ④ e inferior ⑤ con la protección de goma ③ (todo incluido en el volumen de suministro).  
- Montar y apretar a 2 Nm los tornillos ⑥ con los anillos de sujeción ⑦ (todo incluido en el volumen de suministro).

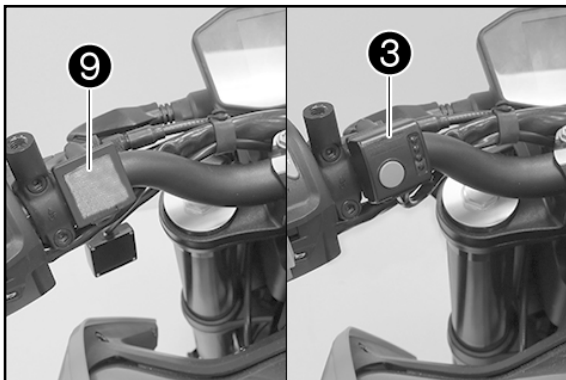

- Pegar la cinta adhesiva de doble cara ⑨ (volumen de suministro) en la fijación superior ④.

- Pegar la unidad de control ③ y, si es necesario, asegurarla con bridas ⑩ (volumen de suministro).

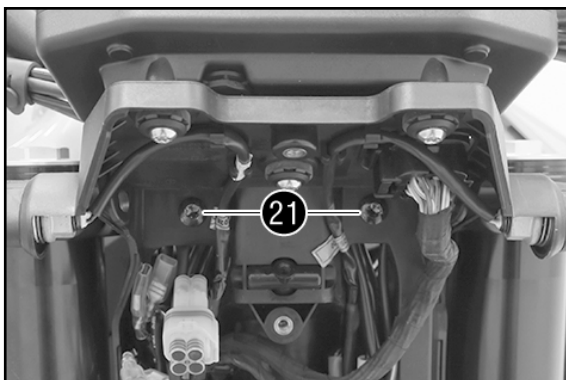

- Montar la tapa y los tornillos ⑳ y apretarlos a 5 Nm.

### ! AVISO

¡Asegurarse de que el cable no pueda retorcerse ni quedar aprisionado!

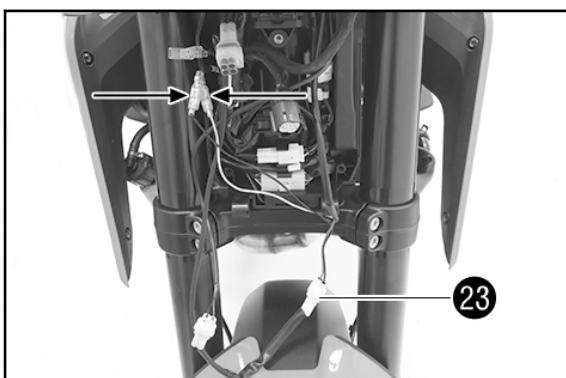

- Enchufar el conector ⑳.  
- Conectar el cableado de la unidad de control con el ACC2 del cableado del vehículo.

### AVISO

Los cables tienen un adhesivo con el texto ACC 2.

- Tender los cables sin tensiones y, si es necesario, asegurarlos con bridas.

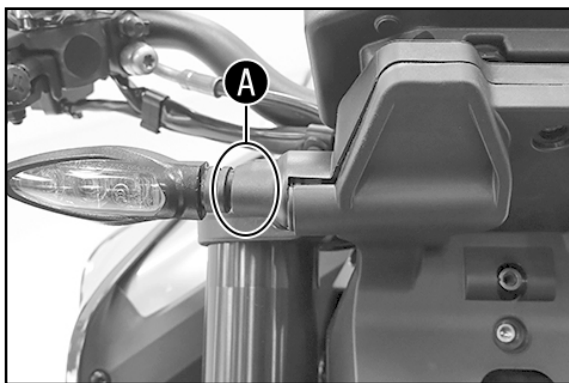

## Ensamblaje

- Colocar la tapa pasando el conector del faro por la abertura.
- Sujetar el intermitente en la zona **A** y empujarlo con cuidado en contra de la dirección de marcha, a la vez que se aprieta la tapa.

✓ La tapa se enclava de manera audible.

- Repetir el paso de trabajo en el lado opuesto.

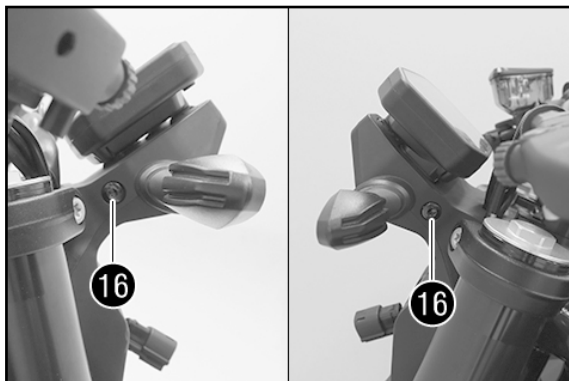

- Montar los tornillos **16** y apretarlos a 5 Nm.
- Montar los tornillos **15** y apretarlos a 5 Nm.
- Montar los tornillos **14** y apretarlos a 2 Nm.

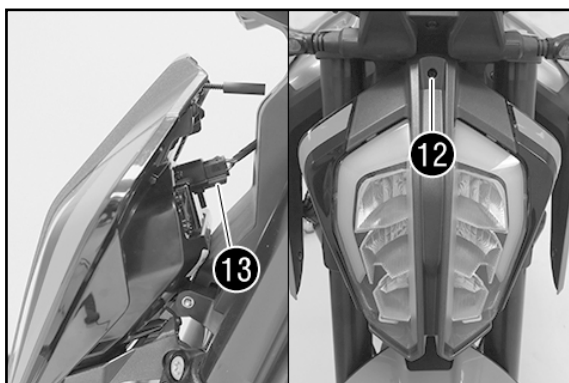
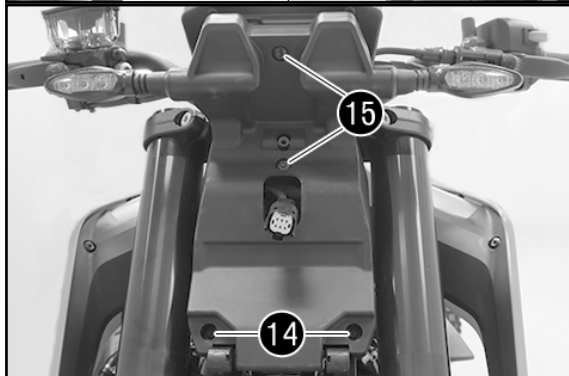

- Enchufar la clema **13**.
- Colocar la máscara de faro.
- Montar el mando de ajuste **12**.

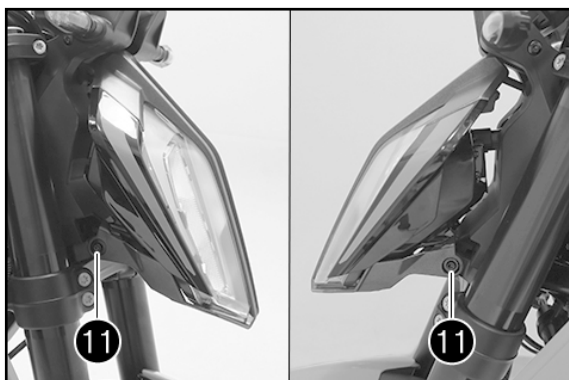

- Montar los tornillos **11** y apretarlos a 2 Nm.

## Trabajos posteriores

- Comprobar el ajuste del faro (véase el manual de instrucciones).
- Ajustar la distancia de alumbrado del faro (véase el manual de instrucciones).



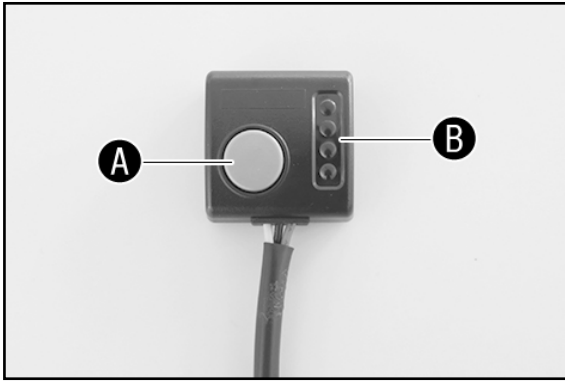

### Conexión

- Mantener pulsado el botón **A** durante aprox. 3 segundos.

✓ El indicador LED **B** muestra el nivel de calefacción correspondiente.

Verde = nivel 1  
Amarillo = nivel 2  
Naranja = nivel 3  
Rojo = nivel 4

### Desconexión

- Mantener pulsado el botón **A** durante aprox. 3 segundos.

✓ El indicador LED **B** está apagado.

### Cambio del nivel de calefacción

- Pulsar el botón **A** para cambiar entre los diferentes niveles de calefacción.

#### AVISO

Al desconectar se guarda el nivel de calefacción seleccionado en ese momento y se activa de nuevo al conectarse otra vez.

### Función de calentamiento rápido

La función de calentamiento rápido está siempre en funcionamiento durante 4 minutos tras la conexión. Durante el calentamiento rápido, el LED del nivel guardado parpadea.

La función de calentamiento rápido puede cancelarse pulsando el botón **A**.

## 790 Adventure

### Montaje de los puños calefactables

- Desconectar el sistema de encendido.
- Retirar los tornillos 11.
- Retirar los dos spoilers del soporte del faro.

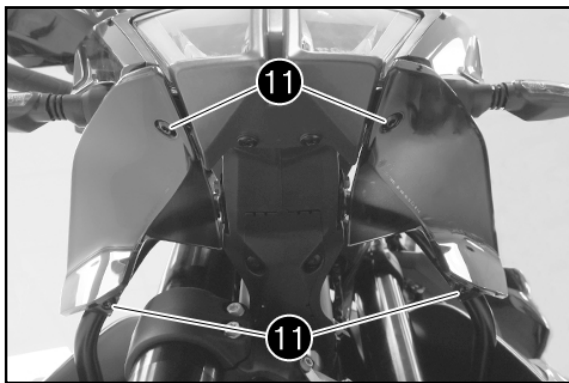

- Retirar los remaches expansibles 12 y abrir la tapa 13.
- Desenganchar el sensor de temperatura 14.
- Retirar la tapa 13.

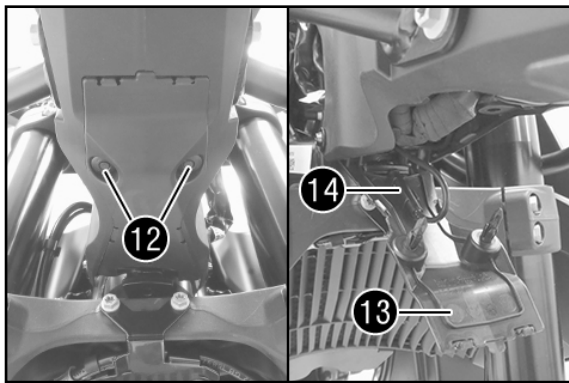

- Aflojar los tornillos 15.
- Retirar los tornillos 16.

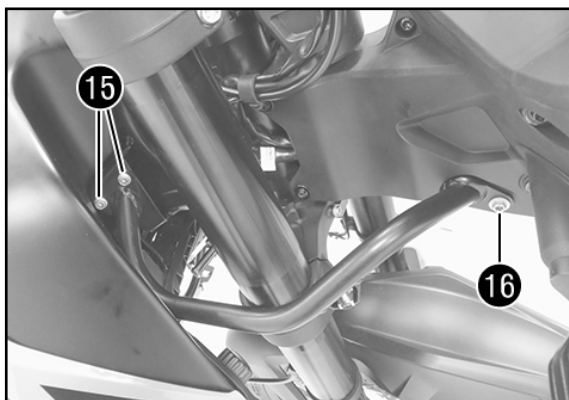

- Retirar los tornillos 17.
  - Tirar del faro hacia delante.
- AVISO**  
Tapar los componentes para que no resulten dañados.

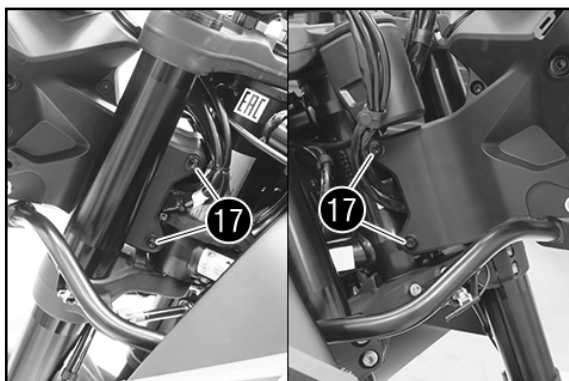

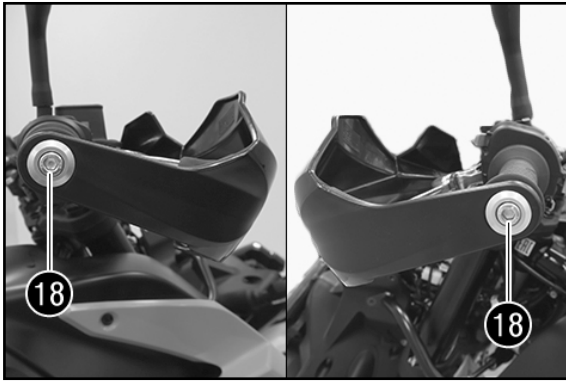

- Aflojar los tornillos 18.

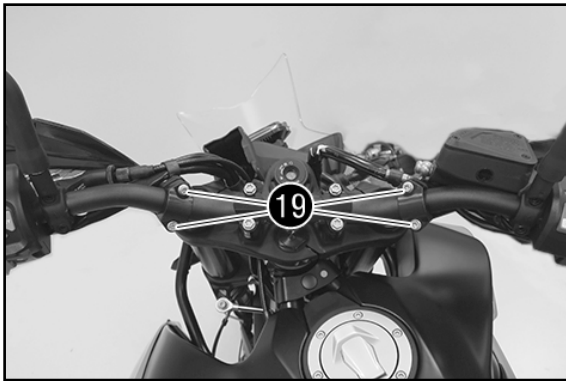

- Retirar las uniones atornilladas 19.  
- Retirar los cubremanos y los contrapesos del manillar.

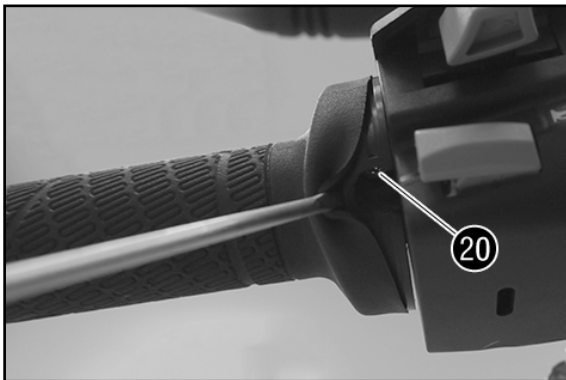

#### Lado izquierdo

- Levantar ligeramente el puño de goma.  
- Aflojar el tornillo 20.  
- Retirar el puño fijo.

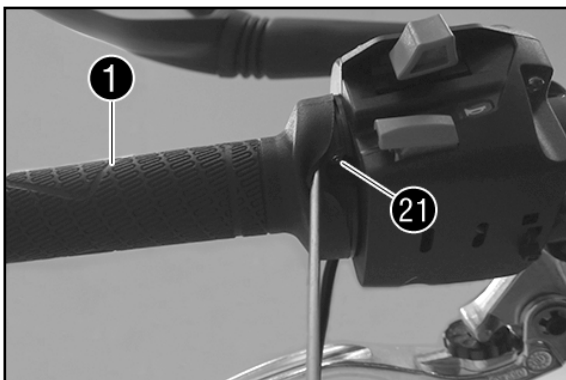

- Colocar el puño calefactable izquierdo 1 (volumen de suministro) en el manillar.  
- Levantar ligeramente el puño de goma.  
- Apretar el tornillo premontado 21.



#### Lado derecho

- Retirar los tornillos 22.  
- Quitar la tapa.  
- Extraer el puño del acelerador del manillar.

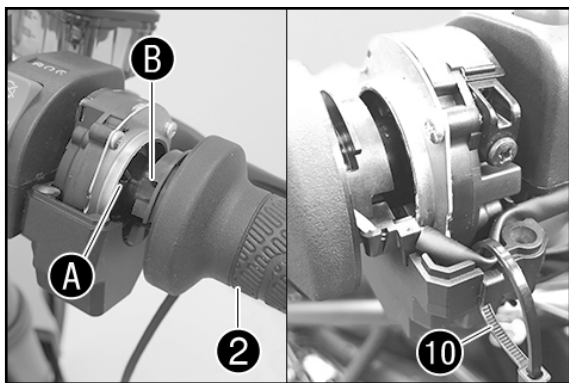

- Colocar el puño calefactable derecho ② (volumen de suministro) en el manillar.

✓ El talón A engrana en el tambor interior de embrague B.

- Tender el cable en el sensor del puño del acelerador sin tensiones (como se muestra en la figura) y asegurarlo con una brida ⑩ (volumen de suministro).

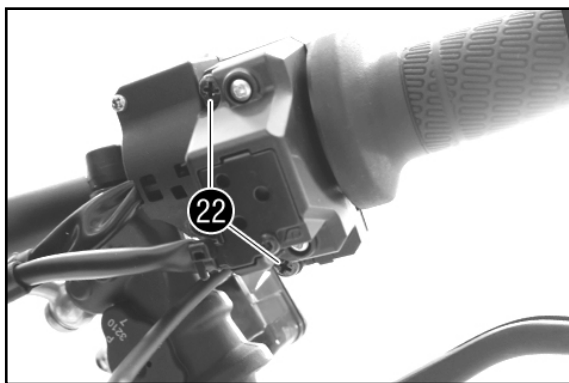

- Colocar la tapa.

### ! AVISO

¡Asegurarse de que el cable no pueda retorcerse ni quedar aprisionado!

- Montar los tornillos originales ②② y apretarlos a 3,5 Nm.



### Tendido de los cables

- Tender el cable del puño calefactable hacia la máscara de faro junto a los demás cables.

- Enchufar el conector ②③ de los dos puños calefactables.

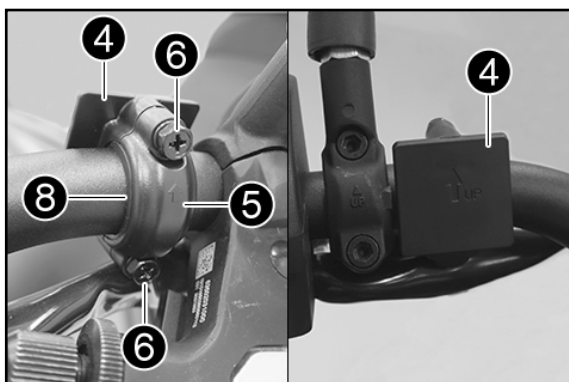

### Montaje de la unidad de control

- Colocar la fijación superior ④ e inferior ⑤ con la protección de goma ③ (todo incluido en el volumen de suministro) en la mitad del manillar deseada.

- Montar y apretar a 2 Nm los tornillos ⑥ con los anillos de sujeción ⑦ (todo incluido en el volumen de suministro).

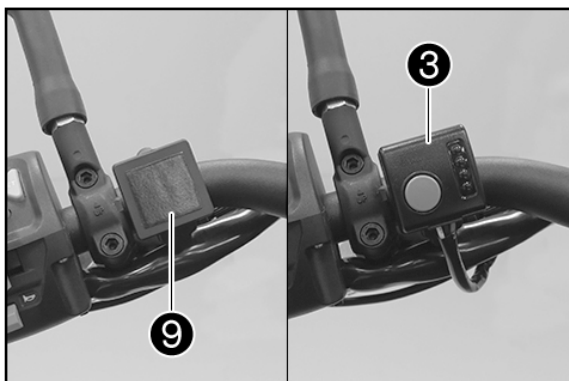

- Pegar la cinta adhesiva de doble cara ⑨ (volumen de suministro) en la fijación.

- Pegar la unidad de control ③ y, si es necesario, asegurarla con bridas ⑩ (volumen de suministro).



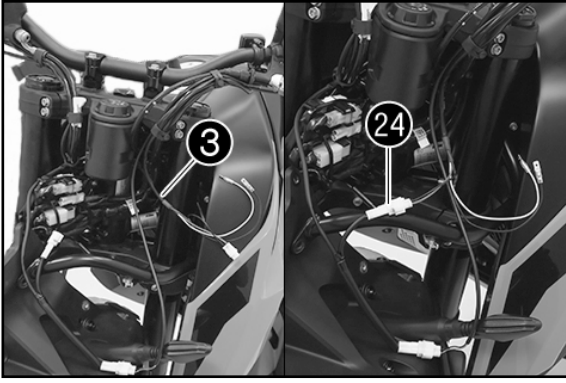

- Tender el cableado de la unidad de control ❸ hacia la máscara de faro junto a los demás cables.

- Enchufar el conector ❹.

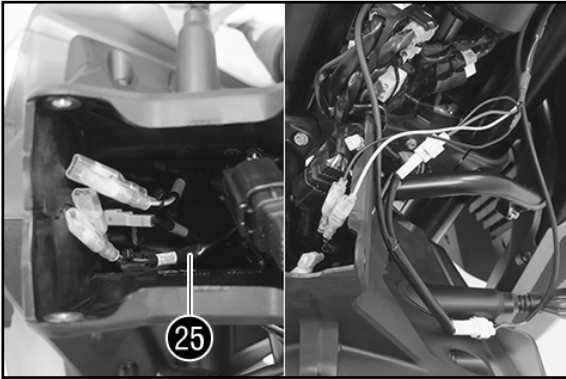

- Extraer el cableado ACC2 ❺ de la máscara de faro.

- Enchufar el cableado de la unidad de control en ACC2 según los colores.

#### AVISO

En los cables hay un adhesivo con el rótulo ACC1 y ACC2.

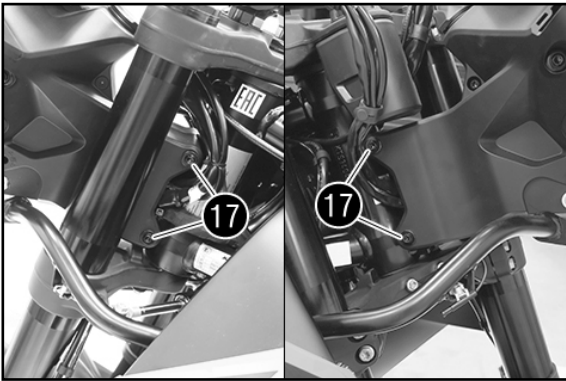

#### Ensamblaje

- Colocar la máscara de faro.

#### AVISO

Tender los cables correctamente y asegurarse de que no queden doblados ni aprisionados.

- Montar los tornillos ❶ y apretarlos a 10 Nm (Loctite 243).



- Montar los tornillos ❷ y apretarlos a 10 Nm (Loctite 243).

- Apretar los tornillos ❷ a 10 Nm.



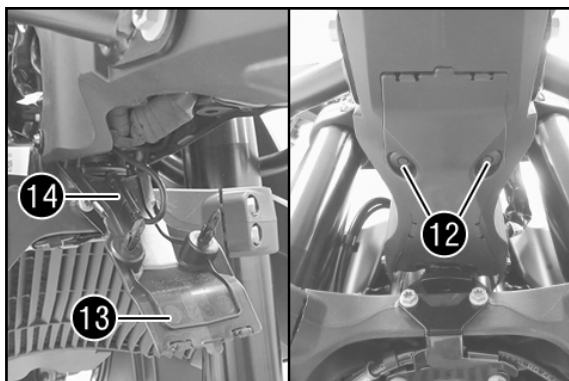

- Posicionar la tapa 13.
- Enganchar el sensor de temperatura 14.
- Montar la tapa con los remaches expansibles 12.

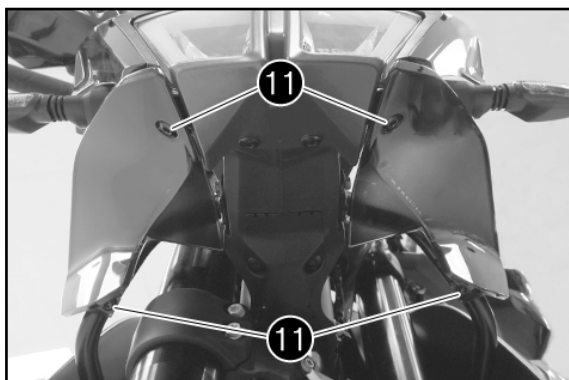

- Colocar los spoilers del soporte del faro.
- Montar los tornillos 11 y apretarlos a 3 Nm.

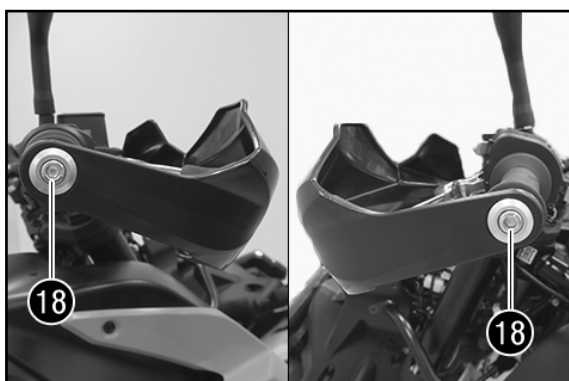

- Colocar los cubremanos con el contrapeso del manillar.
- Apretar el tornillo 18 a 25 Nm.

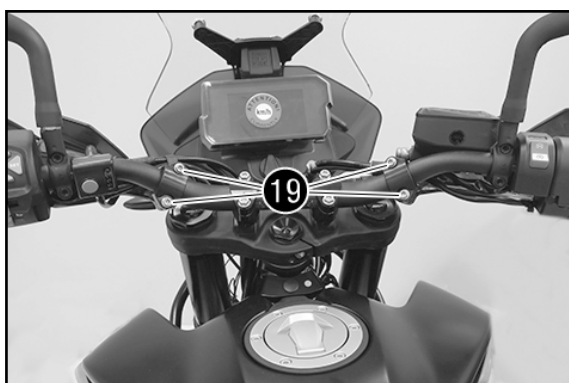

- Colocar los cubremanos en el manillar.
- Montar las uniones atornilladas 19 y apretarlas a 6 Nm.

#### Trabajos posteriores

- Comprobar el ajuste del faro (véase el manual de instrucciones).

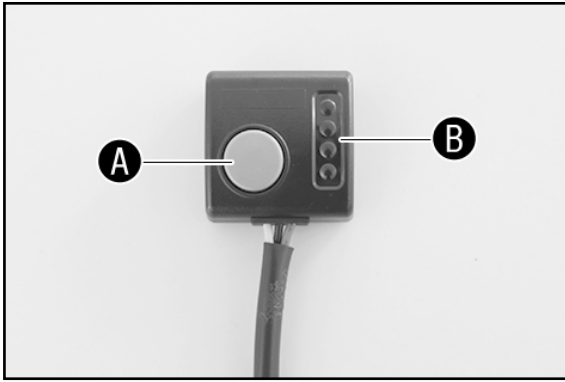

### Conexión

- Mantener pulsado el botón **A** durante aprox. 3 segundos.

✓ El indicador LED **B** muestra el nivel de calefacción correspondiente.

Verde = nivel 1  
Amarillo = nivel 2  
Naranja = nivel 3  
Rojo = nivel 4

### Desconexión

- Mantener pulsado el botón **A** durante aprox. 3 segundos.

✓ El indicador LED **B** está apagado.

### Cambio del nivel de calefacción

- Pulsar el botón **A** para cambiar entre los diferentes niveles de calefacción.

#### AVISO

Al desconectar se guarda el nivel de calefacción seleccionado en ese momento y se activa de nuevo al conectarse otra vez.

### Función de calentamiento rápido

La función de calentamiento rápido está siempre en funcionamiento durante 4 minutos tras la conexión. Durante el calentamiento rápido, el LED del nivel guardado parpadea.

La función de calentamiento rápido puede cancelarse pulsando el botón **A**.